

Wind Power Today

Federal Wind Program Highlights



U.S. Department of Energy
Energy Efficiency and Renewable Energy

Bringing you a prosperous future where energy is clean, abundant, reliable, and affordable

Wind and Hydropower
Technologies Program



**Wind and Hydropower Technologies Program —
Harnessing America’s abundant natural resources for clean power generation**

2004 Wind Energy Research Highlights

U.S. wind energy capacity approaches 7000 MW in 2004 3

DOE negotiates cost-shared projects worth \$60 million 7

Clipper prototype ready for field-testing 7

Southwest Windpower prototype installed at NREL for IEC certification 7

SNL completes fabrication of and begins testing glass/carbon hybrid blades 9

**SNL collaborates with NREL and GE Energy for turbine field tests and
atmospheric data collection 11**

NREL works with NOAA to develop advanced forecasting techniques and products 12

Wind Powering America sponsors 3rd Annual All States Wind Summit 16

Wind Powering America team releases 6 new state wind resource maps 16

DOE hosts 2-day workshop to explore deepwater technologies 21

DOE joins global effort to expand wind energy applications 22

Contents

WIND POWER TODAY

Wind Industry Poised for Record Growth	2
Developing Innovative Cost-Reducing Technologies	3
Cultivating Market Growth	4
Ensuring Our Energy Future	4

FROM DESIGN TO DEPLOYMENT

Helping Industry Build a Viable Technology	6
Building Multimegawatt Prototypes	7
Developing Distributed Wind Prototypes	7
Reducing Component Costs	7
Providing Technical Support to Industry	11

WIND POWERING AMERICA

Cultivating Market Growth	14
State-Based Activities	15
Rural Economic Development	17
Utility Partnerships	18
Native American Wind Power	18

ENSURING OUR ENERGY FUTURE

Developing New Applications	20
Offshore Development	20
Developing Deep Water Technologies	20
Wind and Water	22
Exploring Wind/Desalination Concepts	22
Wind and Hydropower to Stabilize Energy Supplies	23

2004 WIND PROGRAM PUBLICATIONS	24
---	-----------



WIND POWER TODAY

Wind Industry Poised for Record Growth

"We need to more fully develop our renewable energy resources to help increase our energy security and diversify our energy supply. Wind power is especially promising. . ."

*— Secretary of Energy
Samuel W. Bodman*

From watts to megawatts, from concept to capacity, the U.S. Department of Energy (DOE) has worked with the U.S. wind energy industry for more than 30 years to turn yesterday's dream for a clean, renewable energy source into today's most viable renewable energy technology. In the past 10 years, the global wind energy capacity has increased tenfold — from 3.5 gigawatts (GW) in 1994 to almost 50 GW by the end of 2004. In the United States, the wind energy capacity tripled from 1600 megawatts (MW) in 1994 to more than 6700 MW by the end of 2004 — enough to serve more than 1.6 million households – and with the renewal of the Federal production tax credit* in October 2004, the U.S. wind energy industry is poised for record growth in 2005. Some wind industry experts predict that installations for 2005 will add more than 2000 MW of capacity.

The phenomenal growth of the wind industry during the past decade can be attributed to supporting government policies and the DOE Wind Program working with

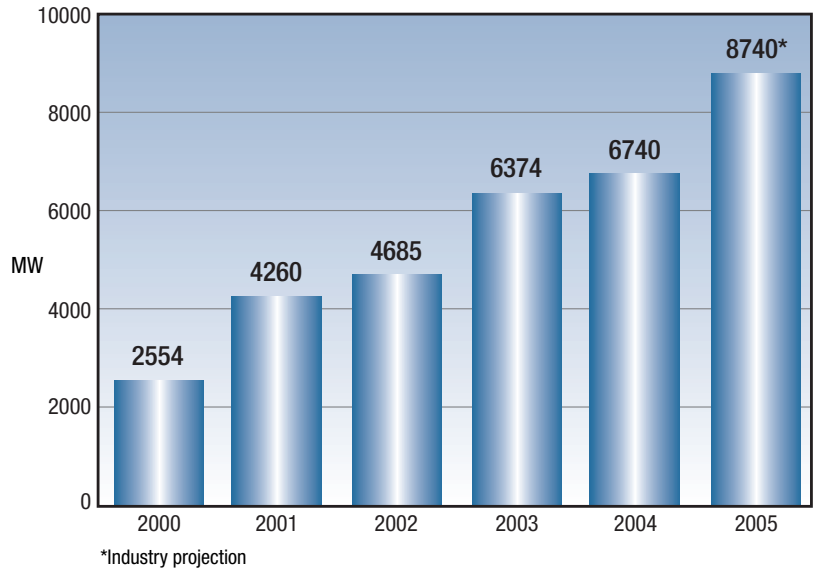

U.S. wind energy capacity 2000–2005.

its industry partners to research and develop innovative cost-reducing technologies, cultivate market growth, and identify new wind energy applications.

Developing Innovative Cost-Reducing Technologies

Work conducted under the DOE Wind Energy Program's Next Generation Wind Turbine (1994 – 2003) and WindPACT (1999 – 2004) projects resulted in

*The federal production tax credit (PTC) provides an inflation-adjusted 1.9 cents per kilowatt-hour tax credit for eligible technologies for the first 10 years of production.

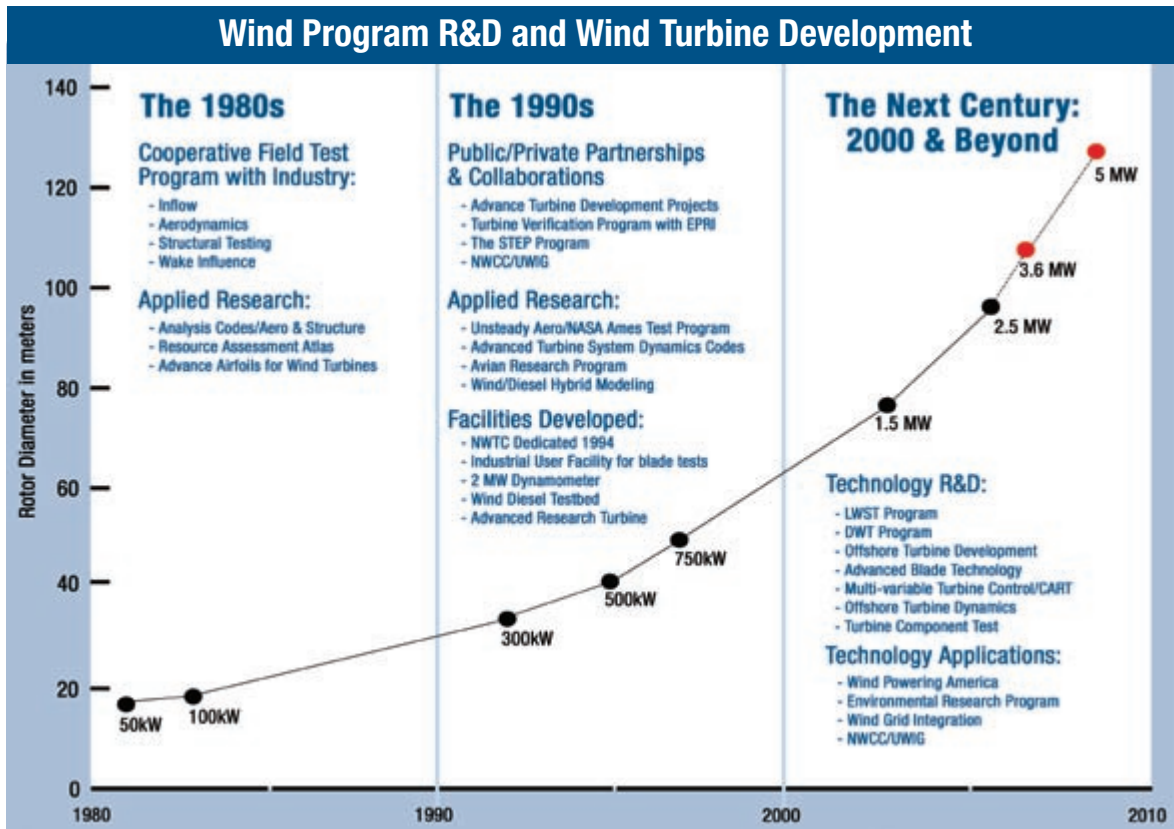



To ensure continued industry growth, DOE's Wind Program is conducting research in new applications such as offshore developments like the Arklow Bank Offshore Wind Park. Located about 10 kilometers off the coast of Arklow, Ireland, the park consists of seven GE Energy 3.6-MW wind turbines.

innovative designs, larger turbines, and increased efficiencies that have led to dramatic reductions in cost — from \$0.80 (current dollars) per kilowatt-hour (kWh) to about \$0.04/kWh for utility-scale turbines.

Although this drop in cost has been impressive, electricity produced by wind energy is not yet fully competitive with that produced by fossil fuels. Researchers believe that further improvements to the technology will reduce the cost of electricity from wind an additional 30%. The Program's goal is to reduce the cost of electricity produced by land-based utility-scale turbines located in Class 4 wind resource areas (areas with 5.8 m/s wind speed at a 10-m height) to \$0.03/kWh and the cost of electricity produced by offshore systems to \$0.05/kWh by 2012. The Program also focuses on improving small, distributed wind technologies in low wind speed areas. The goal of its distributed wind effort is to reduce the cost of electricity from small wind systems to \$0.10 – \$0.15/kWh in Class 3 wind resource areas (5.3 m/s at a 10-m height) by 2007.

Cultivating Market Growth

To cultivate market growth through increasing technology acceptance, DOE's Wind Powering America (WPA) team works with industry partners to provide state support, develop utility partnerships, conduct tribal outreach, and develop innovative market mechanisms to support the use of large- and small-scale wind systems. The goal of WPA is to increase the use of wind energy in the United States so that at least 30 states have 100 MW of wind capacity by 2010.

Ensuring Our Energy Future

Decades of work conducted through public private partnerships have moved wind energy from yesterday's dream to today's reality. To ensure continued industry growth in 2005 and beyond, the Wind Program is exploring innovative applications that will open new markets. These applications include offshore deepwater development, the use of wind energy to clean and move water, and developing new technologies that will enable wind to work in synergy with other renewable energy technologies like hydropower and hydrogen. ♦



Wind Energy Multiyear Program Plan

Vision of Wind Future

Wind energy will become a major source of energy for the nation, which has only begun to tap its vast wind resources. The wind community has set a target of 100 gigawatts (GW) of wind electric capacity installed in the United States by 2020. At that level of use, wind will displace about 3 quadrillion Btus (British thermal units) of primary energy per year and 65 million metric tons of carbon equivalent per year. Extensive deployment of smaller wind systems in distributed settings is also part of industry's target. The DOE Wind Program embraces that vision of the future potential for wind.

As the Wind Program looks to the future, there appear to be three development paths that utility-scale wind technology may follow. Each of the three paths will have its own set of technology challenges and will encounter its own unique non-technology barriers. All three of these paths emanate from current technology, which is oriented toward producing bulk power from land-based wind farms.

Land-Based Electricity Path

As the Program looks to the future, it envisions that the size of land-based systems will continue to increase to the 2 MW – 5 MW range. This path is an important focus of the current DOE program and is expected to result in very cost-competitive turbine technology by 2012. The Program's efforts will also open up vast resources to wind development and will bring wind-generated electricity closer to major load centers. Turbine technology development efforts, such as are described in the Multi-Year Plan, will help the technology to become more cost-competitive. Ultimately, the primary barriers to

the use of this technology will be those presented by system integration issues, including the capability and availability of the U.S. transmission system.

Offshore Electricity Path

The second evolution pathway envisioned is a migration of current technology to offshore sites. At first, this will be into relatively shallow waters, and then later into deeper waters. These turbines are expected to be significantly larger — in the 5 MW and greater range. The Program has a goal of 5 cents/kWh for Class 4 shallow water sites by 2012, and is currently evaluating an appropriate goal for deepwater technology. As the technology progresses along this pathway, in addition to cost, regulatory (siting) barriers are likely to be the most significant obstacles to offshore development.

Emerging Applications Path

The third evolution pathway leads toward the design of turbine systems tailored for emerging applications like hydrogen production or for the production and delivery of clean water. The production of hydrogen would open up an opportunity for wind to provide low-cost, clean energy for the transportation sector. Both of these applications present significant new challenges to the wind community, and cost and infrastructure barriers are expected to be significant. The Program's vision is that this evolution pathway will begin to have an impact on the marketplace in the post-2020 timeframe.

To read more about the U.S. Department of Energy Wind Program Multiyear Program Plan For 2005 – 2010, visit www.eere.energy.gov/windandhydro/.





FROM DESIGN TO DEPLOYMENT

Helping Industry Build a
Viable Technology

*DOE partnered with
Clipper Wind Power to
accelerate the
development of this
advanced 2.5-MW
turbine now beginning
field testing at Medicine
Bow, Wyoming.*

Building Multimegawatt Prototypes

To achieve its goals, the Wind Program launched a Low Wind Speed Technologies (LWST) Project in 2001. A request for proposals (RFP) provided bidders an opportunity to participate in one of three technical areas: 1) concept and scaling studies, 2) component development, and 3) full-scale prototype turbine development. In 2002, the first contracts were awarded, and researchers at DOE's National Renewable Energy Laboratory (NREL) and Sandia National Laboratories (SNL) began working with industry partners to identify LWST projects that would address technology improvement opportunities (TIOs) to further increase efficiency and reduce costs. In July 2003, DOE released another RFP to start the second phase of the LWST effort. At the Global WindPower Conference in 2004, DOE announced that negotiations would begin for 21 public-private partnerships to greatly expand potential U.S. wind development through advances in cost-effective low wind speed technology. The value of the cost-shared projects is expected to total \$60 million over the next 4 years, and the selected companies plan to share up to 50% of the overall project costs.

Several companies selected for LWST partnerships will develop prototypes for both utility-scale and small, distributed wind applications. Two companies are developing utility-scale prototypes: GE Wind Energy and Clipper Windpower.

In 2004, Clipper Windpower completed the fabrication of most of the components for its 2.5-MW Liberty prototype turbine. The prototype incorporates a distributed drivetrain, advanced blades with truncated root section airfoils, and advanced controls. NREL completed dynamometer testing on the new drivetrain in January 2005, and the company began construction on a site for its new turbine in Wyoming. Clipper plans to begin field tests on the prototype in 2005, including a full suite of certification tests. After the successful completion of the tests, Clipper will begin manufacturing their new multimegawatt machines.

GE Wind Energy and its predecessor companies have worked with DOE to develop more efficient turbines since 1994. Since then, the company has sold thousands of turbines that are products of R&D partnerships with DOE. GE Wind is now working with the program to complete a design conceptualization for a 2- to 5-MW prototype turbine that includes advanced controls and diagnostic systems, an innovative drivetrain, blades that incorporate advanced materials and load alleviation, and a taller tower.

A third multimegawatt system development subcontract from the LWST second phase solicitation is under negotiation.

Developing Distributed Wind Prototypes

DOE also works with several companies to develop more efficient distributed wind prototypes. Bergey Windpower has developed a 50-kW turbine, Northern Power Systems is working on a 100-kW turbine, Southwest Windpower completed a 1.8-kW prototype, and Abundant Renewable Energy and Wetzel Engineering are both working on preliminary designs.

Northern Power Systems began redesigning its 100-kW cold weather turbine for agricultural applications. The company's design goal is to reduce the cost of energy (COE) from \$0.12/kWh to \$0.08/kWh at low wind sites by increasing energy capture, reducing initial costs, increasing reliability, and lowering maintenance costs. The design will incorporate a larger 20-m rotor; a direct-drive, variable-speed drivetrain; and its controller and power converter will be located in its nacelle.

Southwest Windpower completed the fabrication of its 1.8-kW Storm prototype turbine. The goals for this project included reducing the COE to \$0.10/kWh at 5.4 m/s and reducing the installation cost to \$3,500. Initial findings indicate that the project will meet or exceed its goals. The prototype was installed at NREL in December 2004 and will be tested to IEC standards for acoustics, power, duration, and safety in 2005.

Abundant Renewable Energy and Wetzel Engineering are both working on preliminary design concepts for small wind turbine systems. Abundant's goal is to develop a design for a 10-kW turbine that will produce electricity for \$0.11/kWh at a site with moderate wind resources. The company completed its conceptual design in June 2004 and hopes to have its preliminary design ready for review by summer 2005. Wetzel Engineering's project goal is to design a 6-kW turbine that can produce electricity for \$0.08/kWh at a Class 3 wind site.

Reducing Component Costs

To support prototype development DOE is also working with its partners to develop more efficient, advanced components for both utility-scale and distributed wind systems. These include new lighter

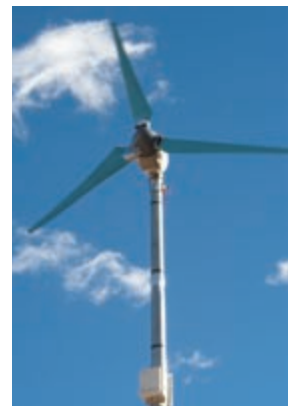

Southwest Windpower's 1.8-kW prototype turbine.



Clipper's new 2.5-MW turbine features an innovative distributed drivetrain.

weight, high-efficiency drivetrains, power converters, and rotors.

Drivetrains

Three of the companies working in partnership with the Wind Program are developing new lower cost utility-scale drivetrains that will undergo testing at NREL's dynamometer test facility. NREL's 2.5-MW dynamometer conducts specialized tests such as gear tooth contact pattern tests, system endurance/fatigue tests, component efficiency tests, generator/power system characterization, advanced lubrication and wear studies, load mitigation testing, wind turbine control simulations, and transient operation. Dynamometer testing services are provided at the request of industry partners and are an integral part of the Program's LWST development activities.

NREL tested two drivetrains for Clipper WindPower in 2004: a 1.5-MW, eight-generator, variable-speed drivetrain and the 2.5-MW distributed-drive, four-generator drivetrain for the Liberty prototype. Clipper's goal is to produce a drivetrain that is 30% lighter and more efficient than conventional drivetrains.

Northern Power Systems constructed a drivetrain to be tested at NREL in 2005. The company completed the design and fabrication of a new 1.5-MW direct-drive permanent-magnet generator with a novel power converter to allow variable-speed operation. Northern Power's goal is to reduce the COE by 2%.

Global Energy Concepts (GEC) also completed a 1.5-MW, single-stage drive, permanent-magnet drivetrain that is scheduled for testing at NREL. The goal of GEC's project is to reduce the COE by 12.8%. GEC completed the design and fabrication of its drivetrain in 2004.

New Generation Motors is conducting a conceptual design study that explores a unique axial flux generator configuration. This design takes advantage of a new variable air gap technology that holds potential for

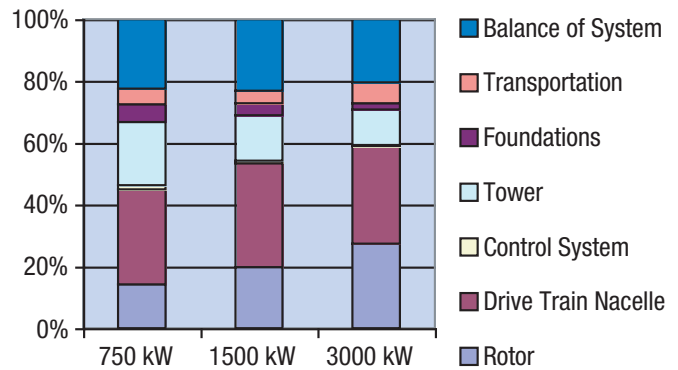

Blade and rotor comprise up to 25% of a wind turbine's total cost.

further reducing generator mass while improving overall generator efficiency.

Another key area in drivetrain design is power conversion through advanced power electronic components. Under phase one of the LWST Project, Northern Power Systems is developing a multimegawatt advanced power converter configuration. This design is optimized for operation with a direct-drive permanent-magnet generator. When completed, the NWTC will test the converter on its dynamometer along with the direct-drive generator developed under WindPACT.

Two additional design studies underway explore alternative approaches to power conversion. One study, conducted by Peregrine Power Technologies, explores the future potential of replacing silicon with silicon carbide in electric switches. Silicon carbide holds promise for handling higher voltages and currents and surviving in higher temperature environments. This could reduce power converter size and improve performance. The second study, performed by Behnke, Erdman, and Whitaker Engineering, explores the use of medium voltage components. Use of voltages higher than the 575- and 690-volt designs currently in use,



SNL researchers work with industry partners to develop the advanced materials and manufacturing processes required by longer blades.

may reduce the overall cost of converter systems as machines grow larger than 1.5 MWs.

Rotors

Because blades and rotor comprise up to 25% of a wind turbine's total capital cost, and the rotor captures 100% of the energy, researchers believe technology improvements in these areas can provide as much as 50% of the cost reduction needed to meet the Wind Program's goal. Researchers at SNL and NREL work with universities and manufacturers to design and fabricate blades that incorporate advanced lighter-weight materials, innovative manufacturing processes, and aeroelastic designs to reduce costs and increase the amount of energy captured by the turbine.

Some of the new materials being developed by SNL researchers include carbon fiber and carbon/glass hybrid composites. Although carbon fibers are more expensive than traditional fiberglass materials, they are much stronger and weigh less than traditional materials.

In 2004, SNL worked with TPI Composites to design and fabricate a glass/carbon hybrid blade that is a scale model of those currently used on utility-scale machines. By using scale models, researchers reduce the cost of evaluating design concepts. The goal of the project is to produce a lighter-weight, more efficient blade that demonstrates new manufacturing processes. The SNL/TPI team fabricated seven of the hybrid prototypes. Two of the prototypes were sent to NREL's NWTC for static and fatigue testing in 2005, two went to SNL for testing and inspection, and three will be field tested at the USDA/Agricultural Research Service site near Bushland, Texas. Another set of seven blades was designed and manufactured to incorporate an innovative passive load control technology called bend-twist coupling. These blades will be used to evaluate design strategies for mitigating turbulence-driven loads that would otherwise increase as the rotor is stretched to capture more energy.

While SNL works with industry to develop the advanced materials and manufacturing processes required by the longer blades, NREL is working to find better ways to test them. In 2004, NREL's NWTC tested the longest blade in the facility's history for TPI Composites. The 45-m blade was 4 meters longer than the facility was designed to handle. To test the longer blades, NREL is building a 50-m blade test stand that will be completed in 2005.

Other rotor studies conducted under the LWST Project are looking at advanced aero controls



NWTC researchers conduct tests on blades designed by SNL to include new materials and manufacturing methods.



NREL is upgrading its blade test facility to provide industry with the means to test longer blades such as TPI's 45-m blade tested at the NWTC in 2004.

techniques. One study, completed in 2004 by Advanced Energy Systems, explored the use of independent blade pitch control. The controller in this study reduced model loads sufficiently to allow a 10% rotor extension and reduced the projected COE 6.3%. A study still underway by Global Energy Concepts is looking at two advanced rotor control methods; devices or methods that can be used to actively alter the local aerodynamic properties of the rotor blade and an actively controlled variable-diameter rotor.

NREL's Small Wind Research Turbine

Helping Industry Produce More Efficient Turbine Designs

To produce more efficient designs, it is important for designers to understand small wind turbine behaviors and how they affect overall performance. Furling is a behavior that designers have found difficult to analyze. Many small turbines use furling to protect the systems from overspeed conditions that can cause damage during excessive winds. On a furling turbine, the rotor either tilts and/or yaws out of the wind.

As designers work to increase the performance with new designs, they use design codes to simulate the turbine performance. In the past, the only design code that was capable of modeling furling turbines was ADAMS, but because ADAMS is very expensive and difficult to use, it was not considered an option by most small wind turbine designers.

To support small turbine design, in 2004, NREL released an upgraded version of its FAST (Fatigue, Aerodynamics, Structure, and Turbulence) design code for horizontal axis wind turbines that incorporates furling. Although the upgraded design code has made it possible to simulate furling behaviors, researchers still lacked the data to validate the models.

In 2003, NREL initiated a Small Wind Research Turbine (SWRT) study to collect the data needed to validate the models for furling wind turbines. For this study, NREL outfitted a 10-kW turbine with instruments to provide accurate thrust measurements — crucial for developing models for furling — and to measure other parameters, such as blade and shaft loads and wind speeds upwind and in the tail wake.

Windward Engineering used NREL's upgraded version of FAST to model the SWRT and compare the model to the test data collected in 2004. The results indicated that although there are some shortcomings in the understanding of wind turbine aerodynamics, the furling dynamics were implemented correctly in the FAST model and that furling could be predicted with reasonable accuracy for the SWRT.

To read more about the SWRT test results, see:

Analysis and Comparison of Test Results from the Small Wind Research Turbine Test Project, NREL/CP-500-36891, <http://www.nrel.gov/docs/fy05osti/36891.pdf>

Development and Validation of an Aeroelastic Model of a Small Furling Wind Turbine NREL/CP-500-36776. 2005 Wind Energy Symposium Technical Papers Presented at the the 43rd AIAA Aerospace Sciences Meeting and Expedition, January 10 – 13, 2005, Reno, Nevada.



The goal of both approaches is to reduce system loads and increase energy capture.

Component Studies

Several additional important component studies under the LWST Project have been completed, are underway, or are in negotiation. One study completed by Berger/ABAM in 2004 examined the use of hybrid steel/concrete towers for the much taller towers needed by multimegawatt turbines. Native American Technologies started another study in 2004 that explores a method to form and fabricate towers on site to reduce fabrication and transportation costs. A third tower study under negotiation will look at advanced self-erecting towers.

Global Energy Concepts is conducting a component study that looks at operations and maintenance costs and is developing a model to assist developers and operators in exploring innovative ways to improve designs and maintenance procedures. Another study under negotiation will research control systems based on forward looking sensors.

Distributed Wind Components

DOE is also working with its industry partners to develop more efficient components for small wind systems. Two companies, Alaska Applied Sciences and Composite Engineering, are developing new blades for retrofit and new system applications. Alaska Applied Sciences is designing a 14-m blade as a retrofit for some of the older machines in the California wind farms. Composite Engineering is designing an optimized 7.5-m turbine blade for 50 – 100-kW machines that will be suitable for use as a retrofit and on new machines. Composite's blade, which will be constructed of low-cost, industrial-grade carbon spars, will be mass-produced by a braiding method. The project goal is to produce a blade that costs less to produce and is lighter, stiffer, and better matched than the original blades.

GEC is working on a concept study to develop a blade flap coupling software tool to control loads. TIAX, LLC, is working on a concept for an axial-flow, permanent-magnet alternator, and Windward Engineering has designed a unique over-speed control system. Although most small wind systems manufactured today have passive controls that allow the turbines to shut down in adverse conditions, the systems do not provide consumers with automatic stopping capabilities. Windward's active control system will allow the owner/operator to shut the system down under all conditions. The company also plans to build a wind turbine on which to test the new control system in 2005.

Two companies are working to improve the design and operation of power converters. Princeton Power



Data Flow from Lamar, Colorado to NWTC to SNL and GE Wind for Field Test

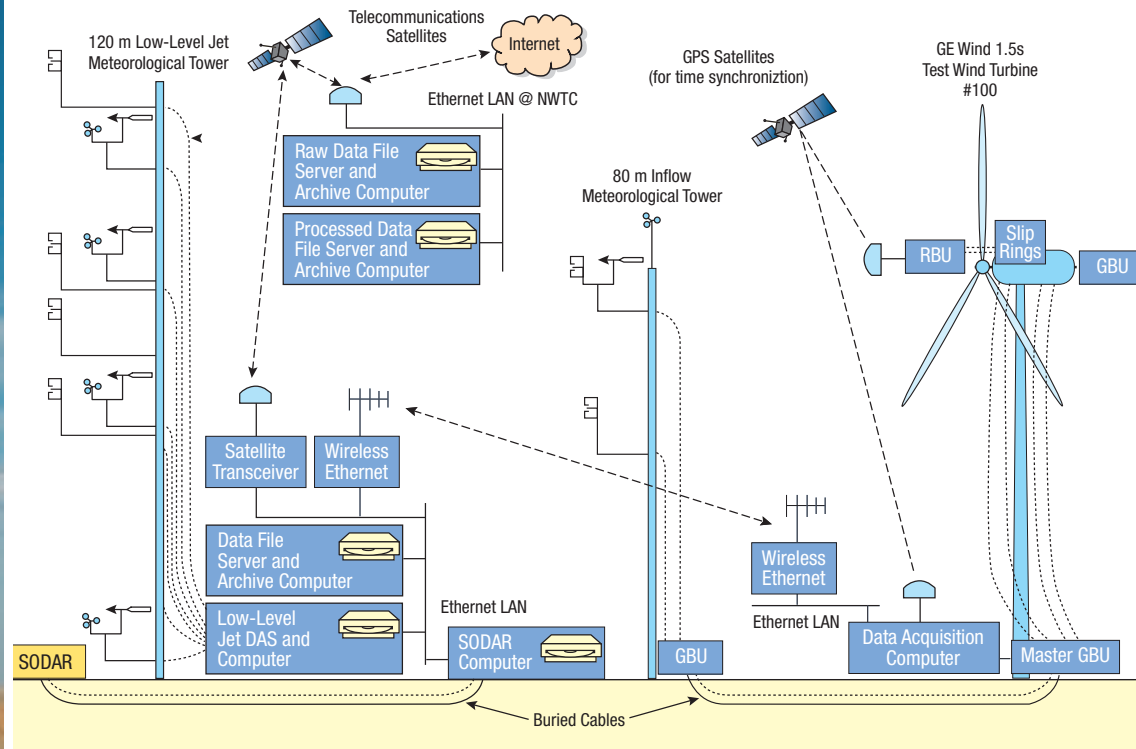

The LIST project near Lamar, Colorado, provides researchers with atmospheric data from a 1.5-MW GE wind turbine, a 120-m tower, and a SODAR acoustic profiler.

Systems completed a preliminary design for a 50-kW converter designed specifically for wind turbines that will reduce costs and increase turbine efficiency. The preliminary design was completed in October 2004, and the company is working to have its final design ready for review by August 2005.

Spellman HV Electronics is designing a 100-kW converter with robust switches, innovative topology, and modularity that will reduce capital costs and increase efficiencies. Spellman completed its design by December 2004 and plans to have the converter tested at SNL in 2005.

Providing Technical Support to Industry

Understand the Inflow

To provide industry with the support it needs to develop technologies capable of cost-effective operation in the low wind speed resource areas, it is important for researchers to understand the complex environment in which the turbines operate. As wind turbines grow in size — 1.5 MW and larger — researchers suspect their components will be subjected to additional wind loading associated with low-level nocturnal jets that occur across the Great Plains during the warmer seasons.

The goal of the Wind Program's Long-Term Inflow and Structural Test (LIST) project is to characterize the environment and determine its impacts on a turbine's

structure and performance. To characterize these potentially damaging events requires a long-term, time-synchronized database that characterizes both the structural responses of the wind turbine and the inflow for at least a wind season.

The LIST project is obtaining this database using atmospheric towers and operating wind turbines of various sizes and configurations at various sites. Each database consists of time-synchronized inflow and structural data that is being used to identify and characterize inflow events that produce large structural loads and to determine the long-term distributions of fatigue loads. The database also provides a resource for validating the ability of the various models for analyzing inflow and turbine behavior to predict these load cases.

With the demonstrated capability to take and archive continuous data from an operating wind turbine, in 2004, the LIST project began the instrumentation and testing of a GE 1.5-MW turbine at a Great Plains location. Data includes direct physical measurements of atmospheric parameters and turbine structural response as well as the remote sensing of atmospheric conditions known to produce organized turbulence that may have substantial operational impacts. The data acquisition system will be based on a combination of the Accurate Time Linked data Acquisition System (ATLAS) units developed by SNL and the custom data acquisition

system for the 120-m tower NREL installed near Lamar, Colorado.

The ATLAS units will acquire data from sensors on the rotating hub, the nacelle, at the base of the wind turbine and on nearby meteorological towers. Simultaneous data acquisition is accomplished by utilizing Global Positioning Satellite (GPS) receivers in conjunction with custom-built programmable logic devices. After only three weeks of operation, the ATLAS had collected more than 48 GB of data. The data collected through the course of the LIST project will help establish the necessary design criteria for low wind speed turbine technology and will determine whether numerical simulations currently being used are adequate.

The Lamar measurement campaign is a joint public/private partnership involving NREL, Sandia, and GE personnel.

For more information about the LIST project read

Update of the Long-Term Inflow and Structural Test Program
<http://www.sandia.gov/wind/topical.htm#ACQ>

Lamar Low-Level Jet Program Interim Report NREL/TP-500-34593 <http://www.nrel.gov/docs/fy04osti/34593.pdf>

In an effort to characterize other complex wind energy resources in various regions of the United States, the Wind Program is working with energy offices in 12 states to collect and analyze data from tall communications towers. The states helped identify 35 to 40 communication towers that would be suitable for participation in this project. Anemometers and vanes have been or will be installed on the towers at several levels, with the top measurement height generally ranging from 90 to 120 meters, depending on the particular tower. There are plans to place wind measurement instruments as high as 600 meters above ground on several towers in Iowa. The towers are located in geographically dispersed locations. The measurement data and the results from the analysis will be made available to the public and will be valuable for different industry stakeholders. Wind shear estimates will be useful to designers, consultants, and developers. Time series and profiles will be useful to utilities for grid integration, and wind speed documentation can be used to validate wind resource maps.

Forecasting the Wind

As the percentage of wind energy in the nation's generation mix grows, it becomes increasingly important for developers, utilities, and system operators to be able to estimate the amount of generation they can expect from the wind plants in their regions. For

developers, being able to predict potential generation will impact the value of the electricity their wind farms produce. For the utilities and system operators, the ability to predict the amount of generation would help with the planning and scheduling required to meet their loads and contractual agreements. Because of the variable nature of a wind farm's resource, estimating its output can be a challenge.

Highly detailed wind resource maps and accurate atmospheric modeling play an important role in determining a wind farm's expected output. Although meteorologists have used atmospheric modeling for more than 30 years, the wind industry did not consider it as a tool for forecasting wind resources until the mid-1990s. Today, accurate models can ensure the success of a development, enabling companies to maximize profits while minimizing risks.

In 2004, NREL worked with the National Oceanic and Atmospheric Administration (NOAA) Forecast Systems Laboratory, using the state-of-the-art numerical weather prediction model, to develop advanced forecasting techniques and products. The long-term objective of this research is to develop forecasting systems that permit scheduling of wind generation on time scales that are useful in energy markets. Accurate forecast products will demonstrate to energy producers that the wind resource is predictable and can be integrated into their system with minimal concern.

Utility Grid Integration

Although the U.S. wind energy capacity has increased steadily during the past 10 years, the industry still faces tough barriers to future deployment. Transmission constraints, operational policies, and a lack of understanding of the impacts of wind energy on utility grids are three of the largest barriers.

Transmission constraints pose one of the most significant barriers facing wind energy development today. In some cases, high-quality wind resources are located far from load centers and existing transmission lines. Because load growth has caught up to existing capacity and minimal new transmission capacity has been added in the past decade, very little excess transmission capacity is available to serve the development of wind resources.

Open access to transmission has been an issue before the Federal Energy Regulatory Commission (FERC) since the Energy Policy Act (EPAAct) of 1992 was enacted. The open access tariffs that transmission providers have filed at FERC limit services available to wind, maintain high costs for transmission services, and include penalties that

adversely affect wind economics and require unrealistic controls. These limits on service, high rate levels, and penalties can make the cost of transmission services prohibitive. FERC is working on a standard set of rules for interconnections between generators and the transmission system. Although interconnection agreements can consume substantial time and effort, FERC seeks to streamline the process. In December 2004, FERC hosted a conference in Denver, Colorado, on the State of Wind Energy in Wholesale Electric Markets. The focus of the conference was short- and long-term measures to ensure that wind energy technology receives nondiscriminatory treatment in electric power markets. As a result of that conference, and in response to a petition submitted by the American Wind Energy Association, on January 24, 2005, FERC issued a Notice of Proposed Rulemaking. In this Notice, the Commission proposes standards that are expected to facilitate the interconnection and economic operation of large wind generating plants.

For more information about the FERC Rulings, see the FERC report *Assessing the State of Wind Energy in Wholesale Electricity Markets* at <http://www.ferc.gov/legal/ferc-regs/land-docs/11-04-wind-report.pdf>.

System integration is another significant barrier to the deployment of wind energy. To feel confident about increasing the amount of wind energy in their generation mix, utility system operators and planners need to understand the effects of fluctuating wind power on system regulation and stability. Without high-frequency wind power data and realistic wind power plant models to analyze the problem, utilities often rely on conservative assumptions and worst-case scenarios to make engineering decisions. To provide the utilities with the data they need, researchers at NREL are recording long-term, high-resolution wind power output data from wind power plants in several regions with a total capacity of 950 MW. Their analysis of the data showed that for normal operation, minute-by-minute fluctuations from a wind plant are, on average, very small: less than 1% for a 1-minute data series or 1 MW for a 100-MW plant. These small variations are well within the range of normal system load variations. The data also suggest that the fluctuations are influenced mainly by the size of the plant and that turbine type and locations play lesser roles.

For more information on the study conducted by NREL, see *Wind Power Plant Behaviors: Analysis of Long-Term Wind Power Data*, NREL/TP-500-36551, <http://www.nrel.gov/docs/fy04osti/36551.pdf>.

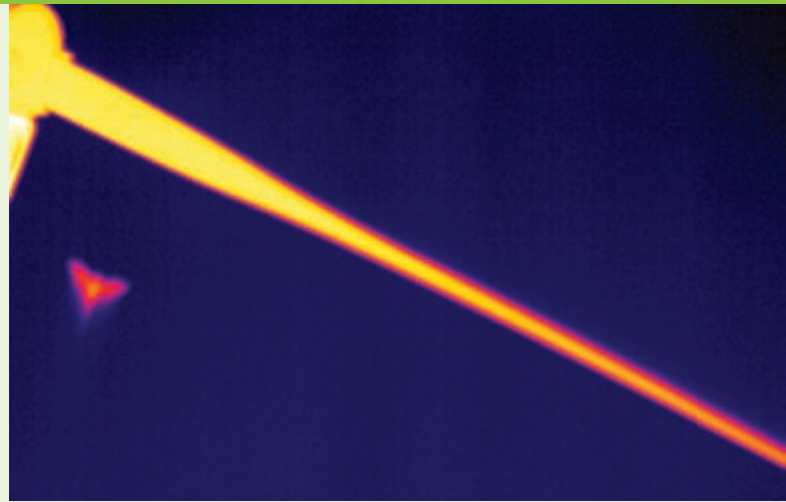

A thermal imaging camera used to study the interactions of bats and wind turbines, captures a bat flying near a turbine at the Mountaineer Wind Energy Facility in West Virginia.

Bats and Wind Energy Cooperative

Bat fatalities reported at wind sites on ridge tops in the eastern United States have given rise to the need for research to help determine the impact that wind facilities might have on bat populations. To address this issue, a collaborative research initiative, the Bats and Wind Energy Cooperative (BWEC), was developed by Bat Conservation International, the U.S. Fish and Wildlife Service (USFWS), the American Wind Energy Association (AWEA), and NREL. The world's leading bat scientists and industry experts gathered at a workshop hosted by BWEC in February 2004 to discuss the type of research needed. Several key research areas were identified, including:

- 1) Conduct daily mortality searches to develop a dataset to evaluate search efforts needed to meet a desired level of precision and accuracy for fatality estimates
- 2) Assess the effects of carcass removal and searcher efficiency bias corrections in making fatality estimates
- 3) Observe the interactions of bats and wind turbines.

For more information about the Bats and Wind Energy Cooperative visit <http://www.batcon.org/projects/layout-projects.html>

In addition to grid integration and transmission constraints, the deployment of wind energy in the United States may be hampered by siting issues that include land use, noise, visual impacts, and impacts on wildlife. Although siting issues may not affect the development of wind projects in many areas of the United States, in some areas, one or more of these issues have in some instances, halted wind projects. Early assessment of the site by the developer is critical to determining how many and which of these topics could be issues that need to be addressed. ♦

To assist developers in evaluating future projects, the NWCC produced a guidebook to siting issues, *Permitting of Wind Energy Facilities: A Handbook*. The guidebook is available at <http://www.nationalwind.org/publications/siting.htm>



WIND POWERING AMERICA

Cultivating Market Growth

When the 162-MW Colorado Green Wind Farm near Lamar, Colorado, came online in December 2003, it secured its place as the fifth-largest wind project in the United States. Perhaps more important, it secured the future of the citizens of Prowers County.

“The Colorado Green wind farm is a win-win project for our community,” said John Stulp, county commissioner for Prowers County. “It has been a significant shot in the arm for the economy during construction, and it’s providing some good permanent jobs.”

According to Stulp, in 2004 the local tax base increased more than \$32 million, or 33%.

“The wind farm is a boost to our local economy and tax base at the same time,” he said. “It diversifies our agriculture-dependent tax base.”

The Prowers County success story exemplifies how rural economies can benefit from wind energy projects. Thanks in part to DOE's Wind Powering America (WPA) effort, launched in 1999, more communities are learning about wind projects and how they can reap the benefits. WPA's primary goal is to increase the number of states with at least 100 MW of wind capacity to 30 by 2010. Reaching this goal will result in increased capital investment in rural America and the creation of new jobs and it will provide a cost-effective option to meet clean air requirements and an enhanced energy and national security future.

To achieve its goal, the WPA national team uses a three-pronged technology acceptance strategy to identify and address barriers to wind development and devise innovative market mechanisms to support the use of large- and small-scale wind:

- 1) State-based technical assistance and outreach
- 2) Utility — public power partnerships
- 3) Native American/Tribal wind assessment and technical support.

State-Based Activities

State-based activities include landowner and community meetings, workshops, state wind working groups, validated state wind resource maps, anemometer loan programs, legislative briefings, outreach activities and materials, and state-specific small wind consumer guides.

WPA's community-based meetings and workshops provide stakeholders with timely information on the current state of wind technology, economics, state wind resources, economic development impacts, policy

Wind Powering America State Activities

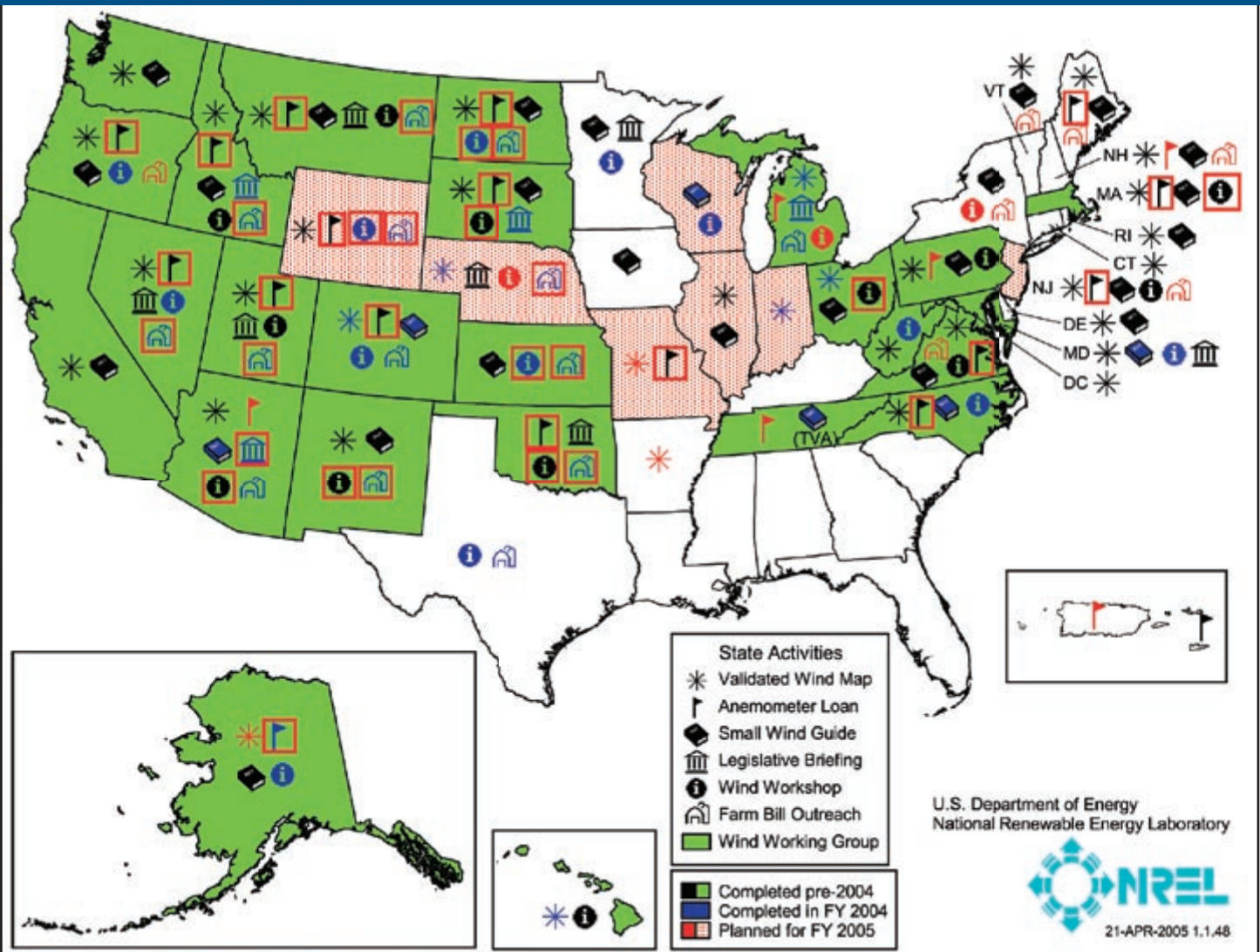

options/issues, and barriers to wind development. These stakeholders include landowners and agricultural sector representatives; utilities and regulators; colleges and universities; advocacy groups; and state and local groups. Most of the program's support is provided to state wind working groups that develop and implement a set of priority activities to encourage wind development in that state. To date, WPA has supported the formation of 22 state wind working groups.

In addition to assisting state wind working groups, WPA helps wind project stakeholders understand their wind resources through cooperative mapping and anemometry programs. WPA supports a public/private sector mix of wind resource analysts and meteorological consultants to update state wind resource maps. Identifying the level of available wind resource in an area is the first step toward installing large and small wind systems.

Although wind project stakeholders have relied on the U.S. Wind Resource Atlas, published in 1987, to guide their efforts, modern mapping systems have produced more highly detailed regional wind maps. The new maps have horizontal resolutions of 1 km (0.6 mi) and finer (in some cases 200 m [656 ft]), in contrast to the old maps that have a resolution of 25 km (15.5 mi). The new technology also enables analysts to overlay the resource maps to show transmission grids; roads; county boundaries; federal, state, and Native American lands; and geographical features. In 2004, the team finalized new maps for Colorado, Indiana, Ohio, Hawaii, Michigan, and

Wind Powering America State Wind Summit III

On April 1 – 2, 2004, WPA sponsored the Third Annual All States Wind Summit following the American Wind Energy Association's Global WINDPOWER conference in Chicago. More than 100 stakeholders attended, including representatives from the following organizations: state energy offices, economic development offices, environmental organizations, energy regulators, universities, rural electric cooperative and public power utilities, and the wind energy industry. WPA Technical Director Larry Flowers presented an Outstanding State Wind Working Group Award to Oregon representative Carel DeWinkel and six Regional Wind Advocacy Awards.

Parallel sessions focused on diverse topics such as state policies, small wind, the 2002 U.S. Farm Bill, grid integration, federal and state lands, rural electric co-ops, working with Tribes, resource assessment, wind for schools, and avian and wildlife issues.

Technology Acceptance Across the United States

WPA's technology acceptance strategy includes extensive outreach. In 2004, WPA team members staffed exhibits at 36 events in Alaska, Arizona, California, Colorado, Connecticut, Idaho, Illinois, Louisiana, Minnesota, Montana, Nevada, New Mexico, North Dakota, Oklahoma, Oregon, South Dakota, Texas, Washington, Wisconsin, and Wyoming. Approximately 43,000 copies of WPA publications were distributed to State Wind Working Groups and various events. The number of visitors to the comprehensive Wind Powering America Web site (www.windpoweringamerica.gov) continues to increase.

Missouri. The maps are available on the WPA Web site at www.windpoweringamerica.gov.

WPA's state-based anemometer loan programs allow landowners to borrow anemometers to measure their wind resources for one year without charge. State lending programs exist in Virginia, Utah, Montana, North Carolina, North Dakota, Idaho, Nevada, Colorado, Missouri, and Kentucky. WPA is working with additional states to organize similar programs. Depending on the state, these programs are run by state energy offices, non-profit organizations, and colleges and universities. WPA encourages local universities to administer the programs for educational purposes.

Small wind systems are another integral element of WPA's state technology acceptance efforts. In 2001, WPA published *Small Wind Electric Systems: A U.S. Consumer's Guide* to help consumers determine whether using wind energy systems to provide all or a part of their home or business electricity needs is economically feasible. WPA team members then collaborated with state energy officials to customize the guide's cover for individual states and include state-specific wind resource maps and information about state incentives and contacts. To date, the WPA team has published guides for 29 states, the American Corn Growers Foundation, and the Tennessee Valley Authority. In 2004, WPA distributed almost 19,000 guides, including guides for the following new states: Colorado, Arizona, Wisconsin, North Carolina, and Maryland. More new guides are planned for 2005. For a complete listing of NREL's small wind guides visit the Publications Database at www.nrel.gov/publications.

WPA also sponsors small wind technical workshops, including Farm Bill, Section 9006 workshops, and provides technical assistance. In 2004, WPA team members participated in workshops in North Carolina,

U.S. Farm Bill Funds Renewable Energy Systems

On April 8, 2003, the U.S. Department of Agriculture (USDA) announced the availability of \$23 million in loans, loan guarantees, and grants for fiscal year 2003 to help farmers, ranchers, and rural businesses purchase renewable energy systems and make energy efficiency improvements. The funds are the result of Section 9006 of the 2002 Farm Bill, which provides funding for wind, solar, biomass, geothermal, hydrogen from renewables, and building and energy efficiency projects.

In 2004, 26 large wind projects in seven states received more than \$7 million in funding, and 12 small wind projects in seven states received almost \$600,000 in funding. This funding provides an excellent vehicle for wind-related rural economic development. As part of its technology acceptance effort, WPA sponsors landowner and community meetings and statewide workshops to communicate these opportunities for wind development to rural communities.

The Tjaden family of Charles City, Iowa, received a \$45,000 USDA grant to install this 450-kW Bonus turbine, which reduces electricity costs and diversifies the farm's assets.

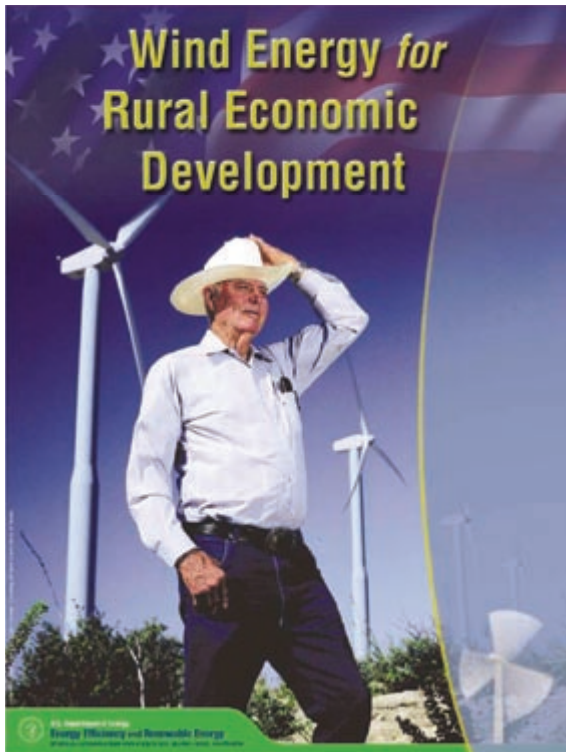

As part of its outreach effort, in 2004 WPA published *Wind Energy for Rural Economic Development*, an eight-page brochure that provides rural stakeholders with information on bringing wind energy projects to their communities.

Wyoming, Texas, Washington, New Mexico, Nebraska, Vermont, Illinois, and Kansas. Team members also staffed a booth at the Midwest Renewable Energy Fair in Wisconsin and distributed literature about small wind projects and Section 9006.

Rural Economic Development

Rural economic development is a key element of Wind Powering America. The WPA team provides economic development analysis tools, case study documentation, and outreach to agricultural and rural development interests. In 2004, WPA also launched an innovative wind for schools project.

The WPA team works with the state wind working groups and their stakeholders to cultivate rural economic development with wind energy by forming partnerships with state agencies. Although the partnerships vary from state to state, they generally include the state energy offices, USDA local and national representatives, state and local officials, the Farm Bureau, the Farmers' Union, representatives of the appropriate growers associations, agricultural schools, and the local financial community.

In 2004, WPA launched an innovative wind for schools pilot program to develop wind projects in rural Eastern Colorado schools. Seventeen towns were identified for their potential wind resource, and school districts in these towns were contacted to determine their interest in pursuing wind projects. The WPA team helps interested communities evaluate their situation, analyze costs and benefits, and determine whether wind power makes sense for each district. Team members evaluate sites, transmission capabilities and accessibility, and the demand and tariff structures for each

service area. One potential project design is the sale of green tags as the main revenue stream to pay off the turbine. If green tags are the revenue source, as opposed to grants and loans, these wind projects can be replicated on a widespread scale.

Utility Partnerships

The key activities of the utility partnerships theme include a public power outreach and recognition program, Power Marketing Administration green tags, and targeted strategic technical analyses (e.g., wind/hydropower system integration and transmission constraints).

Regional transmission constraints, operational policies, and a lack of understanding of the impacts of wind energy on utility grids are three barriers to the future development of wind energy. WPA works to overcome these barriers and meet its goals of increasing the nation's wind energy capacity by working with utilities and utility groups like the American Public Power Association (APPA), the National Rural Electric Cooperative Association (NRECA), Power Marketing Administrations (PMAs), the National Wind Coordinating Committee's (NWCC's) Transmission Working Group, and the Utility Wind Interest Group (UWIG).

WPA works closely with the utility sector, especially national consumer-owned and public power utilities. These cost-shared efforts include co-sponsorship of wind-specific meetings, conferences, and workshops, as well as joint development and distribution of materials containing technical and market-specific information and wind project success stories. WPA also provides real-time technical assistance on the state of wind technology and economics, and information on barriers to and benefits of wind and how to begin a wind project.

WPA also presents two national awards—Wind Cooperative of the Year in conjunction with the National Rural Electric Cooperative Association (NRECA) and Wind Municipal Utility of the Year in conjunction with the American Public Power Association (APPA) — to recognize leadership within those communities in support of wind power.

In February 2004, WPA and NRECA presented Holy Cross Energy, located in Glenwood Springs, Colorado, with the Wind Cooperative of the Year Award. Holy Cross was recognized for its leadership in conducting one of the nation's oldest and most successful green pricing programs. The co-op's approximately 5% participation rate ranks it in the top five utilities nationally.

In October 2004, WPA and APPA presented Fort Collins Utilities of Fort Collins, Colorado, with the Public Power Wind Pioneer Award for vision, leadership, and outstanding community support for renewable energy. In April 1998, Fort Collins Utilities became the first utility in Colorado and among the first in the nation to deliver wind energy for residential and business subscribers.

The WPA team also works with utilities and researchers to develop wind power plant analysis models that utilities can use to predict the impacts of large wind power plants on their grids. WPA works with Power Marketing Administrations (PMAs) such as the Bonneville Power Administration (BPA) and Western Area Power Administration (WAPA), on analysis, development options, and green tag opportunities.

Native American Wind Power

WPA Native American wind activities include supporting the development of the Native American Wind Interest Group (NAWIG), providing outreach materials and technical assistance to interested Tribes, attending Tribal meetings and workshops, offering an anemometer loan program, and hosting the annual Wind Energy Applications and Training Symposium.

The WPA team also works with Native American Tribes in collaboration with the DOE Tribal Energy Program to explore development of tribal wind power resources. The United States is home to more than 700 Native American Tribes and Native Alaskan villages and corporations located on 38.8 million hectares (96 million acres) in the United States. Many of these Tribes and villages have excellent wind resources that could be commercially developed to meet their electricity needs or for electricity export. However, several key issues must be overcome before these resources can be fully developed. These issues include lack of wind resource data, tribal utility policies, sovereignty, perceived developer risk, limited loads, investment capital, technical expertise, and transmission to markets.

To address these issues, WPA provides outreach materials and conducts workshops to provide information about the wind development process and options available to Native Americans. WPA also supports the Native American Wind Interest Working Group (NAWIG) to exchange experiences, concerns, and information on wind development. In addition to the continued publication of NAWIG News: The Quarterly Newsletter of the Native American Wind Interest Group, in-depth interviews with Native American leaders are posted on the WPA Web site at www.eere.energy.gov/

NREL Anemometer Loan Program Sites: January 10, 2005

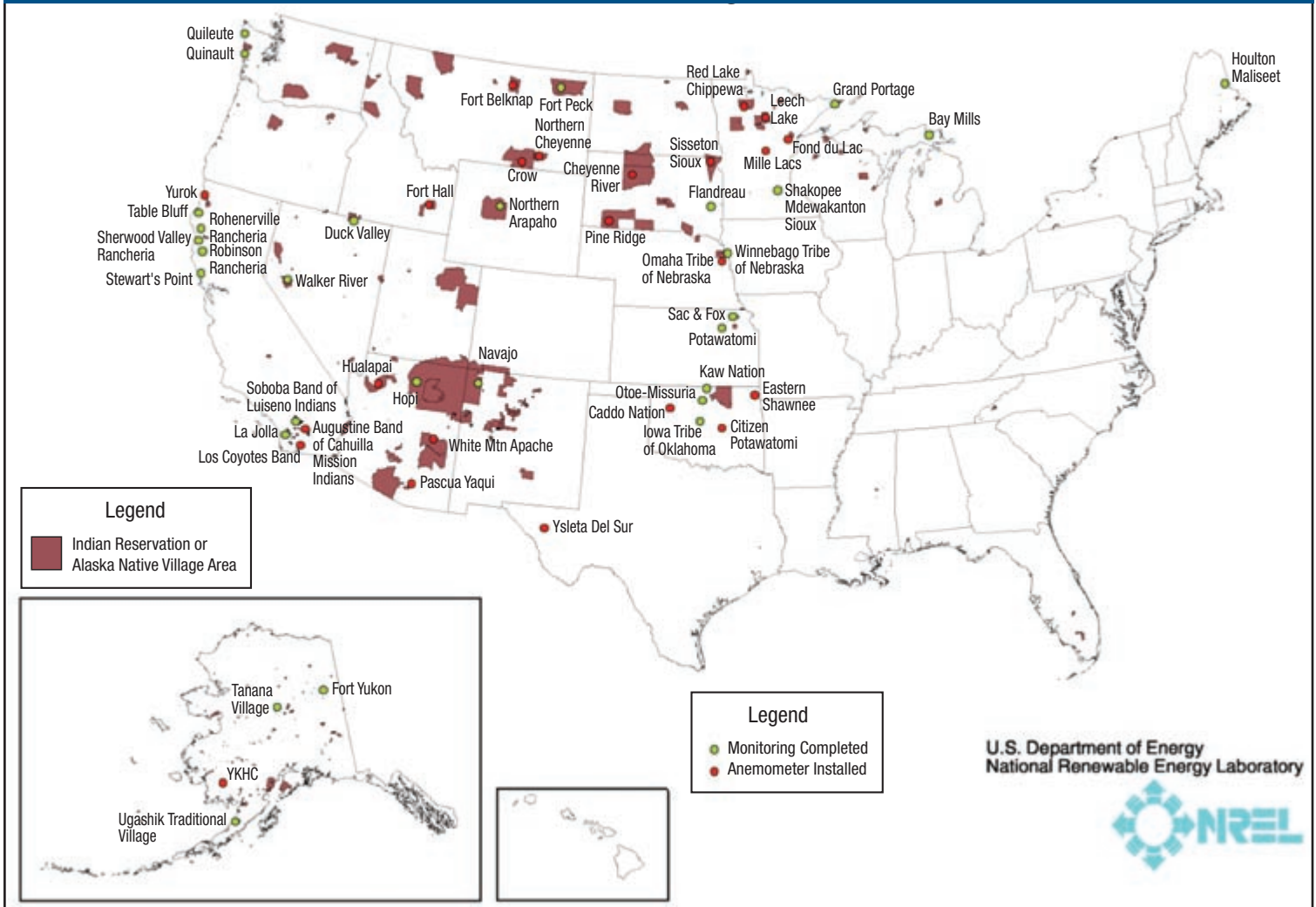

windandhydro/windpoweringamerica/. WPA team members also distribute the Wind Powering Native America video released in 2003.

To help assess the wind resources on tribal lands, NREL and the WAPA manage the Native American Anemometer Loan Program. The program allows Native American Tribes to borrow anemometers and the equipment needed for installation. By significantly reducing the cost of quantifying the wind resource on tribal lands, more Tribes will be encouraged to examine the development of their wind resources. NREL researchers provide technical assistance for siting, installation,

and data analysis. By the end of 2004, 64 locations (cumulative) had installed anemometers, with monitoring complete at 36 locations.

During the last week of August, NREL hosted the annual Wind Energy Application and Training Symposium. Members of Native American Tribes with anemometer loans, current or pending Tribal energy program grants, or reservations located in windy areas were among the invited participants. The 42 participants included 19 representatives from 14 Native American Tribes and organizations. ♦

ENSURING OUR ENERGY FUTURE



This satellite photo shows the heavy concentration of loads in coastal areas.

Developing New Applications

To ensure the wind energy industry a firm place in our nation's clean energy future, program researchers are exploring innovative applications such as offshore deepwater development, the use of wind power to clean and move water, and new technologies that will enable wind energy to work in synergy with other energy technologies such as hydropower and hydrogen.

Offshore Development

Higher quality wind resources (reduced turbulence and increased wind speed), proximity to loads (many demand centers are near the coast), increased transmission options, potential for reducing land use and aesthetic concerns, and the easing of turbine size constraints due to transportation and installation are a few of the advantages drawing attention to offshore wind energy development. Recent studies show significant offshore wind resources in regions of the United States in close proximity to major urban areas in the mid-Atlantic and Northeast. According to David Garman, Under Secretary, U.S. Department of Energy, "... there may be, conservatively speaking, more than 100 gigawatts of capacity just off New England."

Although early studies show great potential for offshore development, the lack of representative observations necessary for estimating the available wind power resource in the offshore environment and

physically consistent modeling of the dynamics within and above the air-sea interface are major issues that need attention. To obtain a more accurate assessment of offshore environments, in 2004, the Wind Program issued a subcontract to AWS Scientific, Inc., to perform a conceptual design study on the development of atmospheric profiling and modeling techniques. The objective of this study is to characterize the offshore wind and wave environment of the Atlantic and lower Great Lakes. The results of this work will assist the offshore wind industry in more precisely quantifying the design load conditions at specific sites, thereby enabling projects to be engineered and operated more cost effectively and with less risk.

Developing Deep Water Technologies

For offshore turbines in very shallow water (less than 30 m [98 ft]), European turbine manufacturers have adopted conventional land-based turbine designs and placed them on concrete bases or steel monopiles and anchored them to the seabed. An offshore substation boosts the collection system voltage, and a buried undersea cable carries the power to shore, where another substation provides a further voltage increase for transmission to the loads. A large amount of the U.S. offshore resources are in waters deeper than those in Europe (30 m and greater), and monopile foundations are unsuitable for these depths. To achieve cost-effective

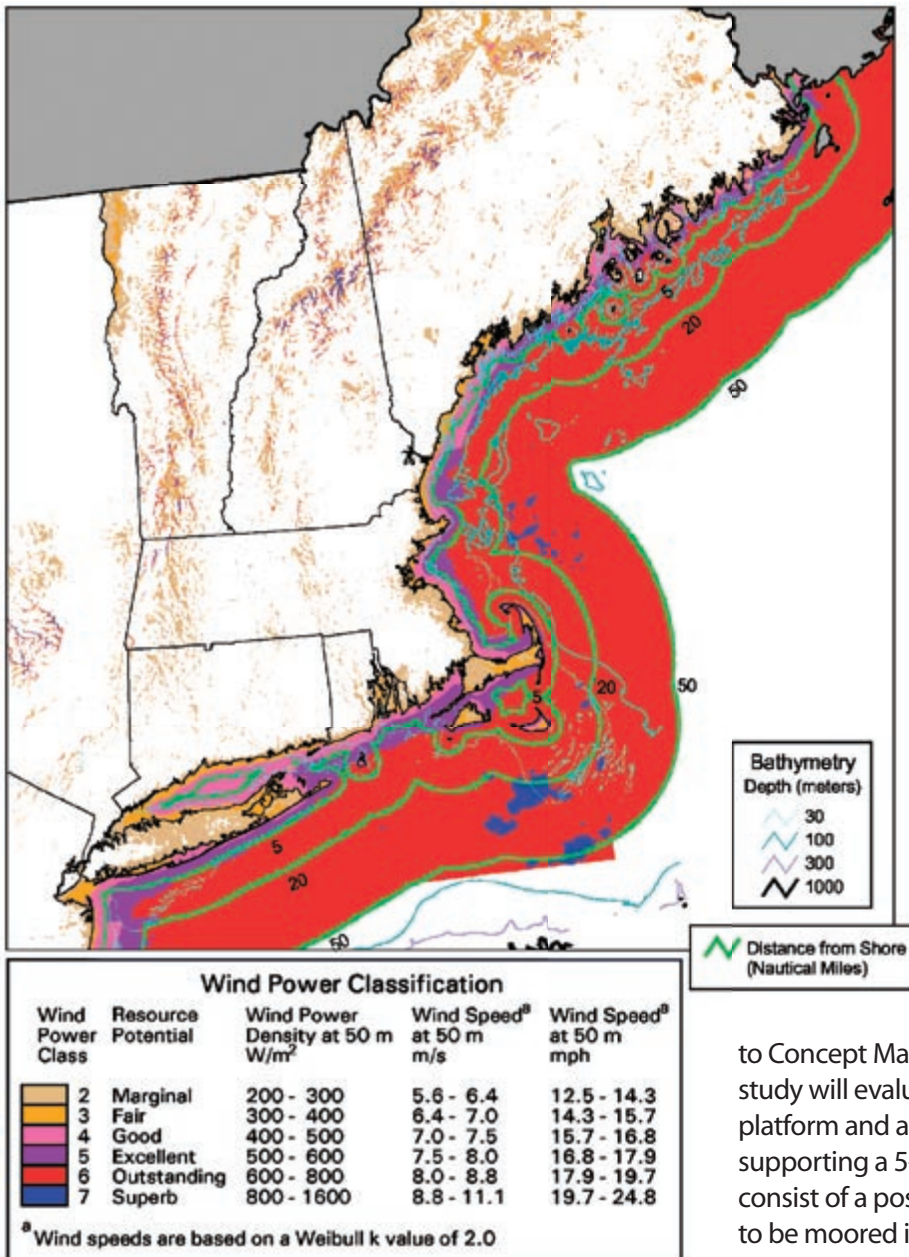

“... there may be, conservatively speaking, more than 100 gigawatts of capacity just off New England.”

**— David Garman,
Under Secretary,
U.S. Department of Energy.**

longer monopiles in deeper water could create dynamically unstable operating conditions. Floating wind energy support structures emerged as one of the promising technologies.

To explore offshore floating wind turbine concepts, the Wind Program awarded a conceptual design study to the Massachusetts Institute of Technology (MIT) in August. The study will employ dynamic response simulations to evaluate at least two floating platform concepts for offshore wind turbines, a moored spar buoy and a tension leg platform, for deployment and cost-effective electricity generation in water depths between 50 and 200 meters.

Another concept study was awarded to Concept Marine Associates, Inc., in September. This study will evaluate and optimize a semi-submersible platform and anchor foundation system capable of supporting a 5-MW wind turbine. The foundation will consist of a positively buoyant concrete platform that is to be moored in deep water and held below the surface of the sea to avoid the majority of wave energy.

In another effort to address the technical, environmental and regulatory issues facing offshore wind energy development, DOE has joined the Massachusetts Technology Collaborative and GE Energy to develop strategic approaches for the development of a sustainable offshore wind industry. The objectives of the collaborative are to:

- Consult with key parties to identify key issues and obstacles to a sustainable offshore wind industry
- Develop a strategic framework for action leading to the successful development of offshore wind industry in the United States, beginning in the Northeast
- Design a business plan that recommends the organizational structure, funding levels and sources, and human resources necessary to implement the strategic framework.

wind energy production in deep water, technologies developed by the oil and gas industries must be simplified, and alternative anchoring methods must be developed.

In October 2004, the Wind Program hosted a two-day workshop to explore technology pathways for installing and operating large offshore wind power facilities in water depths greater than current technologies allow. Approximately 60 experts from the offshore wind energy, oil and gas, and marine industries attended to define near-term priorities and a U.S. R&D agenda. Most of the meeting attendees agreed that monopiles are economically limited to depths of less than 25 m because the size and complexity of installing piles in deep water exceeds the practical limitations of available equipment. Another drawback would be because the decreased stiffness of

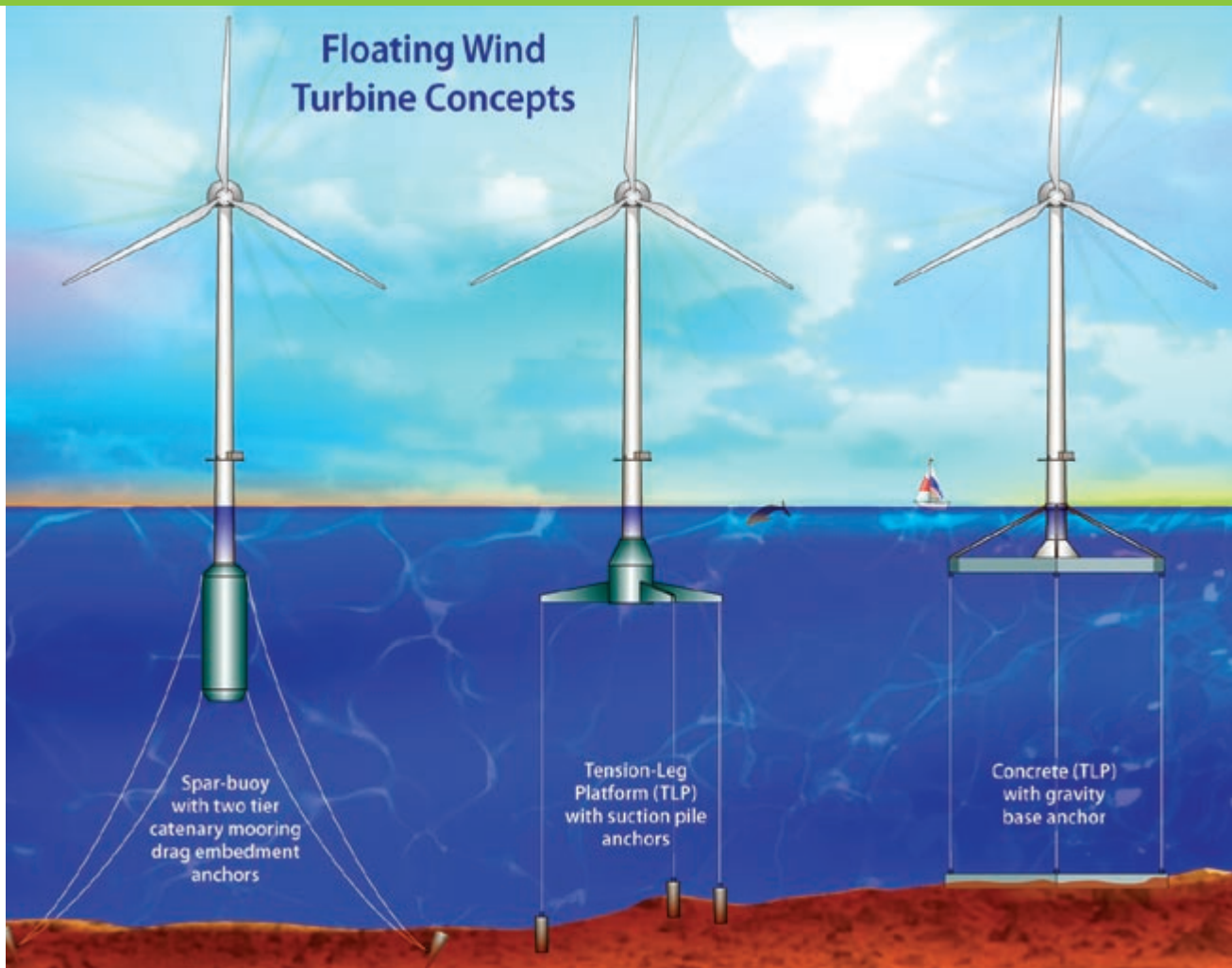

To achieve cost-effective wind energy production in deep water, technologies developed by the oil and gas industries must be simplified and alternative anchoring methods must be developed.

DOE Joins Global Effort to Expand Offshore Wind Energy Development

As part of an effort to address the challenges of offshore development on an international level, in March 2004, the International Energy Agency's (IEA) Executive Committee approved a proposal for an offshore wind energy annex. The purpose of Annex XXIII — Offshore Wind Energy Technology Development is to provide its participants with an overview of the technical and environmental challenges encountered in offshore applications and to help them understand the need for additional research. The Annex was divided into two subtasks: Subtask 1: Offshore Wind — Experience with Critical Deployment Issues, and Subtask 2: Offshore Wind — Technical Research for Deeper water (>30 m). Subtask 1, to be led by Risø National Laboratory in Denmark, will address critical near-term deployment issues. Subtask 2, to be led by NREL in the United States, will address the research needs for deepwater development.

The Offshore Annex held its first meeting in October 2004 in Washington, D.C. Meeting participants included the United States, Denmark, the United Kingdom, Japan, and Norway. The collaborative research topic discussed was *Coupled Turbine/Substructure Dynamic Modeling*.

To learn more about Annex XXIII, visit www.ieawind.org

The Wind Program is also negotiating a subcontract for the development of the first multimewatt wind turbine prototypes expressly developed for offshore deployment.

Wind and Water

The Wind Program is also investigating ways in which wind and water can work together to provide a more stable supply of electricity and fresh water. Fresh-water scarcity is a growing global problem. According to the United Nations, the world's burgeoning population will need billions of cubic meters of fresh water per day by 2025. The current global desalination capacity is estimated at only 28 million cubic meters per day.

Exploring Wind/Desalination Concepts

An important solution to water scarcity is desalination of abundant ocean salt water, but desalination is a highly energy-intensive technology. Among all the desalination process technologies, reverse osmosis has demonstrated the highest electrical energy efficiency at 3–8 kWh per cubic meter of water. Even with this higher efficiency, energy accounts for about 40% of total desalinated

water cost by reverse osmosis. From both energy cost and environmental points of view, inexpensive and clean alternative power sources are needed to provide a low-cost desalination solution. Wind power is the most promising and least expensive renewable power source, but because of its variable nature, researchers need to determine the effects it will have on desalination systems and their operation.

In October 2004, GE Global Research was awarded a conceptual design study on integrated wind energy/desalination systems. The project will explore wind/desalination concepts, identify technical issues, explore feasibility of alternative concepts and evaluate their economic viability. This effort is unique in that it addresses the constraints of variable power input on desalination system operation to arrive at a process capable of

accommodating a maximum level of wind turbine power variation while remaining economically viable.

Wind and Hydropower to Stabilize Energy Supplies

To provide a stable supply of electricity to the grid, the Wind Program is also conducting research into the potential benefits of combining wind and hydropower. As part of that effort, the United States was instrumental in the formation of the IEA RD&D Wind Annex XXIV on the Integration of Wind and Hydropower Systems. The Annex will conduct cooperative research concerning the generation, transmission, and economics of integrating wind and hydropower systems and provide a forum for information exchange. The Annex held its first meeting at the Hoover Dam in Nevada in February 2005. ♦

U.S. Department of Energy Wind Program Research Facilities



NREL's National Wind Technology Center

Designated as the lead research facility for the wind program, the NWTC conducts research and provides its industry partners with support in design and review analysis; aerodynamics; component development; systems and controls analysis; structural, dynamometer, and field testing; certification; utility integration; resource assessment; subcontract management; and outreach.

Sandia National Laboratories

Based in Albuquerque, New Mexico, SNL conducts research in advanced manufacturing, component reliability, structural analysis, and material fatigue.



2004 Wind Program Publications

A complete listing of Wind Program publications, past and present, can be accessed at <http://www.nrel.gov/publications>.

Technical Reports and Papers

"A Comparison of Standard Coherence Models for Inflow Turbulence With Estimates from Field Measurements," Saranyasoontorn, Korn and Manuel, Lance. *Journal of Solar Energy Engineering*, November 2004, Vol. 126, no. 4, pp 1069–1082.

"A Comparison of Wind Turbine Design Loads in Different Environments Using Inverse Reliability Techniques," Saranyasoontorn, Korn and Manuel, Lance. *Journal of Solar Energy Engineering*, November 2004, Vol. 126, no. 4, pp 1060–1068.

"Acoustic Tests of Small Wind Turbines." Migliore, P.; van Dam, J.; Huskey, A. *Collection of the 2004 ASME Wind Energy Symposium Technical Papers at the 42nd AIAA Aerospace Sciences Meeting and Exhibit*, 5–8 January 2004, Reno, Nevada. New York: American Institute of Aeronautics and Astronautics, Inc. (AIAA) and American Society of Mechanical Engineers (ASME); pp. 529–542; NREL Report No. CP-500-36503.

Accurate GPS Time-Linked Data Acquisition System (Atlas II) Users Manual, Zayas, Jose, Jones, P., and Ortiz-Moyet, J., SAND2004-0481, Sandia National Laboratories, Albuquerque, New Mexico, February 2004.

Adaptive Torque Control of Variable Speed Wind Turbines. Johnson, K. E. NREL Report No. TP-500-36265, 107 pp. National Renewable Energy Laboratory, Golden, Colorado. <http://www.nrel.gov/docs/fy04osti/36265.pdf>

Advanced Control Design and Field Testing for Wind Turbines at the National Renewable Energy Laboratory. Hand, M. M.; Johnson, K. E.; Fingersh, L. J.; Wright, A. D. NREL Report No. CP-500-36118, 8 pp. National Renewable Energy Laboratory, Golden, Colorado. <http://www.nrel.gov/docs/fy04osti/36118.pdf>

"Aeroelastic Stability Predictions for a MW-Sized Blade," Lobitz, Don W. *Wind Energy Journal*, 2004:7:211-224.

Alaska Village Electric Load Calculator. Devine, M.; Baring-Gould, E. I. NREL Report No. TP-500-36824, 31 pp. National Renewable Energy Laboratory, Golden, Colorado. <http://www.nrel.gov/docs/fy05osti/36824.pdf>

Analysis and Comparison of Test Results from the Small Wind Research Turbine Test Project, Corbus, D.; Prascher, D. NREL Report No. CP-500-36891, 16 pp. National Renewable Energy Laboratory, Golden, Colorado. <http://www.nrel.gov/docs/fy05osti/36891.pdf>

"Analysis of Autonomous Renewable Energy Systems with Grid Control Interchanged between Diesel and Inverter." A.A.M. Sayigh, ed. *Proceedings of the World Renewable Energy Congress VIII (WREC 2004)*, 29 August–3 September 2004, Denver, Colorado (CD-ROM). [Amsterdam]: Elsevier, Ltd.; Monterey, CA: Produced by InControl Productions, Inc.; 5 pp.; NREL Report No. CP-500-36209.

Avian Monitoring and Risk Assessment at the Tehachapi Pass Wind Resource Area; Anderson, R.; Neumann, N.; Tom, J.; Erickson, W. P.; Strickland, M. D.; Bourassa, M.; Bay, K. J.; Sernka, K. J. Period of Performance: October 2, 1996–May 27, 1998. 102 pp.; NREL Report No. SR-500-36416. National Renewable Energy Laboratory, Golden, Colorado. <http://www.nrel.gov/docs/fy04osti/36416.pdf>

"Baseline Results and Future Plans for the NREL Controls Advanced Research Turbine," Fingersh, L. J.; Johnson, K. E. *Collection of the 2004 ASME Wind Energy Symposium Technical Papers at the 42nd AIAA Aerospace Sciences Meeting and Exhibit*, 5–8 January 2004, Reno, Nevada. New York: American Institute of Aeronautics and Astronautics, Inc. (AIAA) and American Society of Mechanical Engineers (ASME); pp. 87–93; NREL Report No. CP-500-36498.

Blade Manufacturing Improvements: Remote Blade Manufacturing Demonstration, Berry, Derek and Lockard, S., SAND2003-0719, Sandia National Laboratories, Albuquerque, New Mexico, May 2003.

Blade Studies for Twist-Coupled Wind Turbine Blades, Locke, James and Valencia, J., SAND2004-0522, Sandia National Laboratories, Albuquerque, New Mexico, June 2004.

Blade System Design Studies Volume II: Preliminary Blade Designs and Recommended Test Matrix, Griffin, Dayton A., SAND2004-0073, Sandia National Laboratories, Albuquerque, New Mexico, June 2004.

California RPS Integration Study: Phase I Summary and Results, Milligan, M.; Kirby, B.; Jackson, K.; Shiu, H.; Makarov, Y.; Hawkins, D. 32 pp.; NREL Report No. CP-500-35947. National Renewable Energy Laboratory, Golden, Colorado. <http://www.nrel.gov/docs/fy04osti/35947.pdf>

"Classification of Off-Grid Renewable Energy Systems with Similar Conditions Based on Battery-Use Profiles." A.A.M. Sayigh, ed. *Proceedings of the World Renewable Energy Congress VIII (WREC 2004)*, 29 August–3 September 2004, Denver, Colorado (CD-ROM). [Amsterdam]: Elsevier, Ltd.; Monterey, CA: Produced by InControl Productions, Inc.; 6 pp.; NREL Report No. CP-500-36876.

Cost Study for Large Wind Turbine Blades: WindPACT Blade System Design Studies, Berry, Derek and Lockard, S., SAND2003-1428, Sandia National Laboratories, Albuquerque, New Mexico, May 2003.



"Design of Controls to Attenuate Loads in the Controls Advanced Research Turbine," Wright, A. D.; Balas, M. J. *Collection of the 2004 ASME Wind Energy Symposium Technical Papers at the 42nd AIAA Aerospace Sciences Meeting and Exhibit*, 5–8 January 2004, Reno, Nevada. New York: American Institute of Aeronautics and Astronautics, Inc. (AIAA) and American Society of Mechanical Engineers (ASME); pp. 76–86; NREL Report No. CP-500-36304. National Renewable Energy Laboratory, Golden, Colorado.

"Design of Controls to Attenuate Loads in the Controls Advanced Research Turbine," Wright, A. D.; Balas, M. J. *Journal of Solar Energy Engineering: Transactions of the ASME*. Vol. 126, November 2004; pp. 1083–1091; NREL Report No. JA-500-37463. National Renewable Energy Laboratory, Golden, Colorado

Design Studies for Twist-Coupled Wind Turbine Blades, Locke, James and Valencia, J., SAND2004-0522, Sandia National Laboratories, June 2004.

"Development and Validation of a Semi-Empirical Wind Turbine Aeroacoustic Code." Moriarty, P. J. *Collection of the 2004 ASME Wind Energy Symposium Technical Papers at the 42nd AIAA Aerospace Sciences Meeting and Exhibit*, 5–8 January 2004, Reno, Nevada. New York: American Institute of Aeronautics and Astronautics, Inc. (AIAA) and American Society of Mechanical Engineers (ASME); pp. 577–586; NREL Report No. CP-500-35101.

"Development of a Web Based Smart Design Tool to Assist in the Development of Remote Area Power Systems Using Renewable Technology." A.A.M. Sayigh, ed. *Proceedings of the World Renewable Energy Congress VIII (WREC 2004)*, 29 August–3 September 2004, Denver, Colorado (CD-ROM). [Amsterdam]: Elsevier, Ltd.; Monterey, CA: Produced by InControl Productions, Inc.; 5 pp.; NREL Report No. CP-500-36863.

"Effect of Load Phase Angle on Wind Turbine Blade Fatigue Damage." White, D.; Musial, W. *Collection of the 2004 ASME Wind Energy Symposium Technical Papers at the 42nd AIAA Aerospace Sciences Meeting and Exhibit*, 5–8 January 2004, Reno, Nevada. New York: American Institute of Aeronautics and Astronautics, Inc. (AIAA) and American Society of Mechanical Engineers (ASME); pp. 45–53; NREL Report No. CP-500-36497.

"Effect of Load Phase Angle on Wind Turbine Blade Fatigue Damage." White, D. L.; Musial, W. D. *Journal of Solar Energy Engineering: Transactions of the ASME*. Vol. 126, November 2004; pp. 1050–1059; NREL Report No. JA-500-37462.

Effect of Mean Stress on the Damage of Wind Turbine Blades, Sutherland, H.J., and J.F. Mandell. *JSEE*, November 2004, vol. 126, no. 4, pp.1041–1049.

"Effect of Mean Stress on the Damage of Wind Turbine Blades," Sutherland, H.J., and J.F. Mandell, *2004 ASME Wind Energy Symposium*, AIAA/ASME, 2004, pp. 32–44.

"Energy Storage and Reactive Power Compensator in a Large Wind Farm." Muljadi, E.; Butterfield, C. P.; Yinger, R.; Romanowitz, H. *Collection of the 2004 ASME Wind Energy Symposium Technical Papers at the 42nd AIAA Aerospace Sciences Meeting and Exhibit*, 5–8 January 2004, Reno, Nevada. New York: American Institute of Aeronautics and Astronautics, Inc. (AIAA) and American Society of Mechanical Engineers (ASME); pp. 114–123; NREL Report No. CP-500-36500.

"Environmental Impacts of Wind Energy Technology." Morrison, M. L.; Sinclair, K.; *Encyclopedia of Energy*. Elsevier Inc.; Vol. 6; pp. 435–448; NREL Report No. CH-500-33832.



Estimation of Fatigue and Extreme Load Distributions From Limited Data With Application to Wind Energy Systems, Fitzwater, LeRoy M., SAND2004-0001, Sandia National Laboratories, Albuquerque, New Mexico, January 2004.

Evaluation of the New B-REX Fatigue Testing System for Multi-Megawatt Wind Turbine Blades. White, D.; Musial, W.; Engberg, S. Preprint. 17 pp.; NREL Report No. CP-500-37075. National Renewable Energy Laboratory, Golden, Colorado. <http://www.nrel.gov/docs/fy05osti/37075.pdf>

Evaluation of RCAS Inflow Models for Wind Turbine Analysis. Illindala, M. S.; Piagi, P.; Zhang, H.; Venkataramanan, G.; Lasseter, R. H.; NREL Report No. TP-500-35109, 42 pp. National Renewable Energy Laboratory, Golden, Colorado. <http://www.nrel.gov/docs/fy04osti/35109.pdf>

Extrapolation of Extreme and Fatigue Loads Using Probabilistic Methods. Moriarty, P. J.; Holley, W. E.; Butterfield, S. P. 42 pp.; NREL Report No. TP-500-34421. National Renewable Energy Laboratory, Golden, Colorado. <http://www.nrel.gov/docs/fy05osti/34421.pdf>

"Feasibility of Floating Platform Systems for Wind Turbines." Musial, W.; Butterfield, S.; Boone, A. *Collection of the 2004 ASME Wind Energy Symposium Technical Papers at the 42nd AIAA Aerospace Sciences Meeting and Exhibit*, 5–8 January 2004, Reno, Nevada. New York: American Institute of Aeronautics and Astronautics, Inc. (AIAA) and American Society of Mechanical Engineers (ASME); pp. 476–486; NREL Report No. CP-500-36504.

Fluid Flow Modeling of Resin Transfer Molding for Composite Material Wind Turbine Blade Structures, Rossel, Scott M., SAND2004-0076, Sandia National Laboratories, Albuquerque, New Mexico, June 2004.

Future for Offshore Wind Energy in the United States: Preprint. Musial, W.; Butterfield, S. 16 pp.; NREL Report No. CP-500-36313. National Renewable Energy Laboratory, Golden, Colorado. <http://www.nrel.gov/docs/fy04osti/36313.pdf>

Geometry and Structural Properties for the Controls Advanced Research Turbine (CART) from Model Tuning: August 25, 2003–November 30, 2003. Stol, K. A. NREL Report No. SR-500-32087, 60 pp. National Renewable Energy Laboratory, Golden, Colorado. <http://www.nrel.gov/docs/fy04osti/32087.pdf>

"Influence of Specific Rating on the Cost of Wind Energy." Malcolm, D. J.; Cotrell, J. *Collection of the 2004 ASME Wind Energy Symposium Technical Papers at the 42nd AIAA Aerospace Sciences Meeting and Exhibit*, 5–8 January 2004, Reno, Nevada. New York: American Institute of Aeronautics and Astronautics, Inc. (AIAA) and American Society of Mechanical Engineers (ASME); pp. 467–475; NREL Report No. CP-500-36507.

Innovative Design Approaches for Large Wind Turbine Blades Final Report, Berry, Derek and Lockard, S., SAND2004-0074, Sandia National Laboratories, Albuquerque, NM, May 2004.

"Insight Into Wind Turbine Stall and Post-Stall Aerodynamics." Tangler, J. L. *Wind Energy*. Vol. 7(3), July/September 2004; pp. 247–260; NREL Report No. JA-500-36198. National Renewable Energy Laboratory, Golden, CO.

Integrating Wind into Transmission Planning: The Rocky Mountain Area Transmission Study (RMATS): Preprint. Hamilton, R.; Lehr, R.; Olsen, D.; Nielsen, J.; Acker, T.; Milligan, M.; Geller, H. NREL Report No. CP-500-35969, 26 pp. National Renewable Energy Laboratory, Golden, CO. <http://www.nrel.gov/docs/fy04osti/35969.pdf>

International Energy Agency Wind Turbine Round-Robin Test Task. Link, H. F.; Santos, R. NREL Report No. TP-500-36238, 41 pp. National Renewable Energy Laboratory, Golden, CO. <http://www.nrel.gov/docs/fy04osti/36238.pdf>

International Energy Agency Wind Turbine Round-Robin Test Task: Final Report. Link, H. F.; Santos, R. NREL Report No. TP-500-35888, 41 pp. National Renewable Energy Laboratory, Golden, CO. <http://www.nrel.gov/docs/fy04osti/36238.pdf>

Job and Economic Development Impact (JEDI) Model: A User-Friendly Tool to Calculate Economic Impacts from Wind Projects; Preprint. Sinclair, K.; Milligan, M.; Goldberg, M. NREL Report No. CP-500-35953, 12 pp. National Renewable Energy Laboratory, Golden, CO. <http://www.nrel.gov/docs/fy04osti/35953.pdf>

Lamar Low-Level Jet Program Interim Report. Kelley, N.; Shirazi, M.; Jager, D.; Wilde, S.; Adams, J.; Buhl, M.; Sullivan, P.; Patton, E. NREL Report No. TP-500-34593, 216 pp. National Renewable Energy Laboratory, Golden, Colorado. <http://www.nrel.gov/docs/fy04osti/34593.pdf>

Lifting Surface and Reynolds Averaged Navier-Stokes Power Predictions for NREL's Phase VI Experiment. A.A.M. Sayigh, ed. *Proceedings of the World Renewable Energy Congress VIII (WREC 2004)*, 29 August–3 September 2004, Denver, Colorado (CD-ROM). [Amsterdam]: Elsevier, Ltd.; Monterey, CA: Produced by InControl Productions, Inc.; 5 pp.; NREL Report No. CP-500-36870.

Load Mitigation Control Design for a Wind Turbine Operating in the Path of Vortices. Hand, M. M.; Balas, M. J. NREL Report No. CP-500-35966, 15 pp. National Renewable Energy Laboratory, Golden, Colorado. <http://www.nrel.gov/docs/fy04osti/35966.pdf>

Low Wind Speed Turbine Project Conceptual Design Study: Advanced Independent Pitch Control; July 30, 2002–July 31, 2004 (Revised). Olsen, T.; Lang, E.; Hansen, A. C.; Cheney, M. C.; Quandt, G.; VandenBosche, J.; Meyer, T. NREL Report No. SR-500-36755, 127 pp. National Renewable Energy Laboratory, Golden, Colorado. <http://www.nrel.gov/docs/fy05osti/36755.pdf>

"Methods for Increasing Region 2 Power Capture on a Variable Speed HAWT." Johnson, K. E.; Fingersh, L. J. *Collection of the 2004 ASME Wind Energy Symposium Technical Papers at the 42nd AIAA Aerospace Sciences Meeting and Exhibit*, 5–8 January 2004, Reno, Nevada. New York: American Institute of Aeronautics and Astronautics, Inc. (AIAA) and American Society of Mechanical Engineers (ASME); pp. 103–113; NREL Report No. CP-500-36499. National Renewable Energy Laboratory, Golden, Colorado.

"Methods for Increasing Region 2 Power Capture on a Variable-Speed Wind Turbine." Johnson, K. E.; Fingersh, L. J.; Balas, M. J.; Pao, L. Y. *Journal of Solar Energy Engineering: Transactions of the ASME*. Vol. 126(4), November 2004; pp. 1092–1100; NREL Report No. JA-500-37441. National Renewable Energy Laboratory, Golden, Colorado.

"Modeling of Aeroacoustic Noise from Wind Turbines." Moriarty, P. J. *Proceedings of the World Renewable Energy Congress VIII (WREC 2004)*, 29 August–3 September 2004, Denver, Colorado (CD-ROM). [Amsterdam]: Elsevier, Ltd.; Monterey, CA: Produced by InControl Productions, Inc.; 6 pp.; NREL Report No. CP-500-36859.

Modern Control Design for Flexible Wind Turbines. Wright, A. D. NREL Report No. TP-500-35816, 233 pp. National Renewable Energy Laboratory, Golden, Colorado. <http://www.nrel.gov/docs/fy04osti/35816.pdf>

Motion Technologies CRADA CRD-03-130: *Assessing the Potential of a Mechanical Continuously Variable Transmission*. Cotrell, J. NREL Report No. TP-500-36371, 21 pp. National Renewable Energy Laboratory, Golden, Colorado. <http://www.nrel.gov/docs/fy04osti/36371.pdf>

Multi-Flexible-Body Analysis for Application to Wind Turbine Control Design: September 10, 1999 -- October 31, 2003. Lee, D.; Hodges, D. H. NREL Report No. SR-500-35228, 105 pp. National Renewable Energy Laboratory, Golden, Colorado. <http://www.nrel.gov/docs/fy04osti/35228.pdf>

"New Developments for the NWTC's FAST Aeroelastic HAWT Simulator." Jonkman, J. M.; Buhl, M. L., Jr. *Collection of the 2004 ASME Wind Energy Symposium Technical Papers at the 42nd AIAA Aerospace Sciences Meeting and Exhibit*, 5–8 January 2004, Reno, Nevada. New York: American Institute of Aeronautics and Astronautics, Inc. (AIAA) and American Society of Mechanical Engineers (ASME); pp. 181–191; NREL Report No. CP-500-36501.

New Method for Dual-Axis Fatigue Testing of Large Wind Turbine Blades Using Resonance Excitation and Spectral Loading. White, D. NREL Report No. TP-500-35268, 195 pp. National Renewable Energy Laboratory, Golden, Colorado. <http://www.nrel.gov/docs/fy04osti/35268.pdf>

Northern Power Systems WindPACT Drive Train Alternative Design Study Report; Period of Performance: April 12, 2001 to January 31, 2005. Bywaters, G.; John, V.; Lynch, J.; Mattila, P.; Norton, G.; Stowell, J.; Salata, M.; Labath, O.; Chertok, A.; Hablanian, D. NREL Report No. SR-500-35524, 404 pp. National Renewable Energy Laboratory, Golden, Colorado. <http://www.nrel.gov/docs/fy05osti/35524.pdf>

Novel Power Electronics Systems for Wind Energy Applications: Final Report; Period of Performance: August 24, 1999 – November 30, 2002. Erickson, R.; Angkititrakul, S.; Al-Naseem, O.; Lujan, G. NREL Report No. SR-500-33396, 121 pp. <http://www.nrel.gov/docs/fy05osti/33396.pdf>



"Offshore Wind Energy Potential for the United States. A.A.M." Musial, W.; Butterfield, S. *Proceedings of the World Renewable Energy Congress VIII (WREC 2004)*, 29 August–3 September 2004, Denver, Colorado (CD-ROM). [Amsterdam]: Elsevier, Ltd.; Monterey, CA: Produced by InControl Productions, Inc.; 7 pp.; NREL Report No. CP-500-36370.

Optimization of Utility-Scale Wind-Hydrogen-Battery Systems: Preprint. Fingersh, L. J. NREL Report No. CP-500-36117, 8 pp. National Renewable Energy Laboratory, Golden, Colorado. <http://www.nrel.gov/docs/fy04osti/36117.pdf>

"Periodic and Non-Periodic Disturbance Accommodating Control of the Controls Advanced Research Turbine (CART)." Street, B. M.; Balas, M.; Stol, K. *Collection of the 2004 ASME Wind Energy Symposium Technical Papers at the 42nd AIAA Aerospace Sciences Meeting and Exhibit*, 5–8 January 2004, Reno, Nevada. New York: American Institute of Aeronautics and Astronautics, Inc. (AIAA) and American Society of Mechanical Engineers (ASME); pp. 124–132; NREL Report No. CP-500-36508.

Parallel Operation of Wind Turbine, Fuel Cell, and Diesel Generation Sources: Preprint. Muljadi, E.; Wang, C.; Nehrir, M. H. NREL Report No. CP-500-35353, 9 pp. National Renewable Energy Laboratory, Golden, Colorado. <http://www.nrel.gov/docs/fy04osti/35353.pdf>

Preliminary Assessment of Potential Avian Interactions at Four Proposed Wind Energy Facilities on Vandenberg Air Force Base, California (2004). NREL Report No. SR-500-34961, 43 pp. National Renewable Energy Laboratory, Golden, Colorado. <http://www.nrel.gov/docs/fy04osti/34961.pdf>

Preliminary Structural Design of Composite Blades for Two- and Three-Blade Rotors. Bir, G.; Migliore, P. NREL Report No. TP-500-31486, 37 pp. National Renewable Energy Laboratory, Golden, Colorado. <http://www.nrel.gov/docs/fy04osti/31486.pdf>

Progress in Implementing and Testing State-Space Controls for the Controls Advanced Research Turbine: Preprint. Wright, A. D.; Fingersh, L. J.; Stol, K. A. NREL Report No. CP-500-36818, 16 pp. National Renewable Energy Laboratory, Golden, Colorado. <http://www.nrel.gov/docs/fy05osti/36818.pdf>

Quantifying the Economic Development Impacts of Wind Power in Six Rural Montana Counties Using NREL's JEDI Model; Period of Performance: December 1, 2003–May 31, 2004. Costanti, M. NREL Report No. SR-500-36414, 42 pp. National Renewable Energy Laboratory, Golden, Colorado. <http://www.nrel.gov/docs/fy04osti/36414.pdf>

"Ramifications of Aeroelastic Analysis Approximations as Blade Designs Approach Stability Boundaries," Lobitz, D. *2004 ASME Wind Energy Symposium*, P. 203–210.

Renewable Energy Water Pumping Systems Handbook; Period of Performance: April 1–September 1, 2001. Argaw, N. NREL Report No. SR-500-30481, 128 pp. National Renewable Energy Laboratory, Golden, Colorado. <http://www.nrel.gov/docs/fy04osti/30481.pdf>

"Rotational Augmentation and Dynamic Stall in Wind Turbine Aerodynamics Experiments. A.A.M." Schreck, S. *Proceedings of the World Renewable Energy Congress VIII (WREC 2004)*, 29 August–3 September 2004, Denver, Colorado (CD-ROM). [Amsterdam]: Elsevier, Ltd.; Monterey, CA: Produced by InControl Productions, Inc.; 6 pp.; NREL Report No. CP-500-36864.

San Juanico Hybrid System Technical and Institutional Assessment: Preprint. Corbus, D.; Newcomb, C.; Yewdall, Z. NREL Report No. CP-500-36270, 8 pp. National Renewable Energy Laboratory, Golden, Colorado. <http://www.nrel.gov/docs/fy04osti/36270.pdf>



Self Excitation and Harmonics in Wind Power Generation: Preprint. Muljadi, E.; Butterfield, C. P.; Romanowitz, H.; Yinger, R. NREL Report No. CP-500-33138, 13 pp. National Renewable Energy Laboratory, Golden, Colorado. <http://www.nrel.gov/docs/fy05osti/33138.pdf>

Stability Analysis of an Adaptive Torque Controller for Variable Speed Wind Turbines: Preprint. Johnson, K. E.; Pao, L. Y.; Balas, M. J.; Kulkarni, V.; Fingersh, L. J. NREL Report No. CP-500-36756, 11 pp. National Renewable Energy Laboratory, Golden, Colorado. <http://www.nrel.gov/docs/fy05osti/36756.pdf>

"The Effect of Mean Stress on Damage Predictions for Spectral Loading of Fiberglass Composite Coupons," Sutherland, H.J., and J.F. Mandell. *EWEA, Special Topic Conference 2004: The Science of Making Torque from the Wind*, 2004, pp. 546–555.

"Tip Speed Ratio Influences on Rotationally Augmented Boundary Layer Topology and Aerodynamic Force Generation." Schreck, S.; Robinson, M. *Collection of the 2004 ASME Wind Energy Symposium Technical Papers at the 42nd AIAA Aerospace Sciences Meeting and Exhibit*, 5–8 January 2004, Reno, Nevada. New York: American Institute of Aeronautics and Astronautics, Inc. (AIAA) and American Society of Mechanical Engineers (ASME); pp. 259–270; NREL Report No. CP-500-36506.

"Tip Speed Ratio Influences on Rotationally Augmented Boundary Layer Topology and Aerodynamic Force Generation." Schreck, S.; Robinson, M. *Journal of Solar Energy Engineering: Transactions of the ASME*. Vol. 126, November 2004; pp. 1025–1033; NREL Report No. JA-500-37453.

Tower Design Load Verification on a 1-kW Wind Turbine: Preprint. Prascher, D.; Huskey, A. NREL Report No. CP-500-37112, 10 pp. National Renewable Energy Laboratory, Golden, Colorado. <http://www.nrel.gov/docs/fy05osti/37112.pdf>

Turbine Research Program Cold Weather Turbine Project: Period of Performance May 27, 1999 – March 31, 2004. Lynch, J.; Bywaters, G.; Costin, D.; Hoskins, S.; Mattila, P.; Stowell, J. NREL Report No. SR-500-36289, 37 pp. National Renewable Energy Laboratory, Golden, Colorado. <http://www.nrel.gov/docs/fy04osti/36289.pdf>

"Update of the Long-Term Inflow and Structural Test Program," Sutherland, H.J., J. Zayas, A. Sterns and B. Neal, *2004 ASME Wind Energy Symposium*, AIAA/ASME, 2004, pp. 140–150.

"Updated Goodman Diagrams for Fiberglass Composite materials Using the DOE/MSU Fatigue Database," Sutherland, H.J., and J.F. Mandell. *Global Windpower 2004*, AWEA/EWEA, Paper # 18983, 12 p.

VAR Support from Distributed Wind Energy Resources: Preprint. Romanowitz, H.; Muljadi, E.; Butterfield, C. P.; Yinger, R. NREL Report No. CP-500-36210, 8 pp. National Renewable Energy Laboratory, Golden, Colorado. <http://www.nrel.gov/docs/fy04osti/36210.pdf>

Validation of Updated State Wind Resource Maps for the United States: Preprint. Schwartz, M.; Elliott, D. NREL Report No. CP-500-36200, 8 pp. National Renewable Energy Laboratory, Golden, Colorado. <http://www.nrel.gov/docs/fy04osti/36200.pdf>

Wind-Battery-Hydrogen Integration Study. Fingersh, L. J. NREL Report No. TP-500-35889, 24 pp. National Renewable Energy Laboratory, Golden, Colorado. <http://www.nrel.gov/docs/fy04osti/35889.pdf>

"Wind Energy Economics." Milligan, M. *Encyclopedia of Energy*. Elsevier Inc.; Vol. 6: pp. 409–418; NREL Report No. CH-500-32872.

Wind Farm Power System Model Development: Preprint. Muljadi, E.; Butterfield, C. P. NREL Report No. CP-500-36199, 8 pp. National Renewable Energy Laboratory, Golden, Colorado. <http://www.nrel.gov/docs/fy04osti/36199.pdf>

Wind Power Impacts on Electric Power System Operating Costs: Summary and Perspective on Work to Date; Preprint. Smith, J. C.; DeMeo, E. A.; Parsons, B.; Milligan, M. NREL Report No. CP-500-35946, 13 pp. National Renewable Energy Laboratory, Golden, Colorado. <http://www.nrel.gov/docs/fy04osti/35946.pdf>

"Wind Powering America: Goals, Approach, Perspectives and Prospects." Flowers, L. T.; Dougherty, P. J. *SAMPE Journal*. Vol. 40(4), July/August 2004; pp. 44–46; NREL Report No. JA-500-36946. National Renewable Energy Laboratory, Golden, Colorado.

Wind Power Plant Behaviors: Analyses of Long-Term Wind Power Data. Wan, Y. H.; NREL Report No. CP-500-36551, 66 pp. National Renewable Energy Laboratory, Golden, Colorado. <http://www.nrel.gov/docs/fy04osti/36551.pdf>

Wind Turbine Post-Stall Airfoil Performance Characteristics Guidelines for Blade-Element Momentum Methods: Preprint. Tangler, J. L.; Kocurek, J. D. NREL Report No. CP-500-36900, 13 pp. National Renewable Energy Laboratory, Golden, Colorado. <http://www.nrel.gov/docs/fy05osti/36900.pdf>

"Wind Resource Base." Elliott, D.; Schwartz, M.; Scott, G. *Encyclopedia of Energy*. Elsevier Inc.; Vol. 6: pp. 465–479; NREL Report No. CH-500-33605.

Wind Tunnel Aeroacoustic Tests of Six Airfoils for Use on Small Wind Turbines; Period of Performance: August 23, 2002 through March 31, 2004. Oerlemans, S. NREL Report No. SR-500-35339, 112 pp. National Renewable Energy Laboratory, Golden, Colorado. <http://www.nrel.gov/docs/fy04osti/35339.pdf>

Wind Tunnel Aerodynamic Tests of Six Airfoils for Use on Small Wind Turbines; Period of Performance: October 31, 2002–January 31, 2003. Selig, M. S.; McGranahan, B. D. NREL Report No. SR-500-34515, 156 pp. National Renewable Energy Laboratory, Golden, Colorado. <http://www.nrel.gov/docs/fy05osti/34515.pdf>

"Wind Tunnel Aeroacoustic Tests of Six Airfoils for Use On Small Wind Turbines." Migliore, P.; Oerlemans, S. *Journal of Solar Energy Engineering: Transactions of the ASME*. Vol. 126(4), November 2004; pp. 974–985; NREL Report No. JA-500-34470.

"Wind Tunnel Aeroacoustic Tests of Six Airfoils for Use on Small Wind Turbines." Migliore, P.; Oerlemans, S. *Collection of the 2004 ASME Wind Energy Symposium Technical Papers at the 42nd AIAA Aerospace Sciences Meeting and Exhibit*, 5–8 January 2004, Reno, Nevada. New York: American Institute of Aeronautics and Astronautics, Inc. (AIAA) and American Society of Mechanical Engineers (ASME); pp. 543–556; NREL Report No. CP-500-36505.

Wind Turbine Field Testing of State-Space Control Designs: August 25, 2003–November 30, 2003. Stol, K. A.; Fingersh, L. J. NREL Report No. SR-500-35061, 39 pp. National Renewable Energy Laboratory, Golden, Colorado. <http://www.nrel.gov/docs/fy04osti/35061.pdf>

"Wind Turbine Response to Analytic Flow Vortex Parameter Variation." Hand, M. M.; Robinson, M. C.; Balas, M. J. *Collection of the 2004 ASME Wind Energy Symposium Technical Papers at the 42nd AIAA Aerospace Sciences Meeting and Exhibit*, 5–8 January 2004, Reno, Nevada. New York: American Institute of Aeronautics and Astronautics, Inc. (AIAA) and American Society of Mechanical Engineers (ASME); pp. 414–423; NREL Report No. CP-500-36502.

WindPACT Rotor Design Study: Hybrid Tower Design; Period of Performance: 29 June 2000 – 28 February 2004. Malcolm, D. J. NREL Report No. SR-500-35546, 44 pp. National Renewable Energy Laboratory, Golden, Colorado. <http://www.nrel.gov/docs/fy04osti/35546.pdf>

Outreach Publications

America's Schools Use Wind Energy to Further Their Goals. Wind and Hydropower Technologies Program (Fact Sheet). (2004). 2 pp.; NREL Report No. FS-500-35512; DOE/GO-102004-1973. <http://www.nrel.gov/docs/fy04osti/35512.pdf>

Job and Economic Development Impact (JEDI) Model: A User-Friendly Tool to Calculate Economic Impacts from Wind Projects (Brochure). (2004). 6 pp.; NREL Report No. BR-500-35872; DOE/GO-102004-1901. <http://www.nrel.gov/docs/fy04osti/35872.pdf>

NAWIG News: The Quarterly Newsletter of the Native American Wind Interest Group, Fall 2004. (2004). 4 pp.; NREL Report No. BR-500-35629; DOE/GO-102004-2038. <http://www.nrel.gov/docs/fy05osti/35629.pdf>

NAWIG News: The Quarterly Newsletter of the Native American Wind Interest Group, Spring 2004. (2004). 4 pp.; NREL Report No. BR-500-35445; DOE/GO-102004-1848. <http://www.nrel.gov/docs/fy04osti/35445.pdf>

NAWIG News: The Quarterly Newsletter of the Native American Wind Interest Group, Summer 2004. (2004). 4 pp.; NREL Report No. BR-500-36418; DOE/GO-102004-1977. <http://www.nrel.gov/docs/fy04osti/36418.pdf>



Wind Energy Finance (WEF): An Online Calculator for Economic Analysis of Wind Projects. (2004). 6 pp.; NREL Report No. BR-500-33638; DOE/GO-102004-1846. <http://www.nrel.gov/docs/fy04osti/33638.pdf>

Wind Energy for Rural Economic Development. (2004). 8 pp.; NREL Report No. BR-500-33590; DOE/GO-102004-1826. <http://www.nrel.gov/docs/fy04osti/33590.pdf>

Wind Powering America: Clean Energy for the 21st Century (Revised). (2004). 6 pp.; NREL Report No. BR-500-35873; DOE/GO-102004-1899. <http://www.nrel.gov/docs/fy04osti/35873.pdf>

Wind Powering Native America: A Tribal Road to Renewable Energy (Video). (2004). ; NREL Report No. OT-500-33137; DOE/GO-102002-1664.

Wind Power Today and Tomorrow. The 2004 Wind and Hydropower Technologies Annual Report. (2004), 32 pp. NREL Report No. BR-500-34915. <http://www.nrel.gov/docs/fy04osti/34915.pdf>

Small Wind Guides

Small Wind Electric Systems: An Arizona Consumer's Guide. (2004). 27 pp.; NREL Report No. BR-500-34935; DOE/GO-102004-1806. <http://www.nrel.gov/docs/fy04osti/34935.pdf>

Small Wind Electric Systems: A Colorado Consumer's Guide. (2004). 27 pp.; NREL Report No. BR-500-31254; DOE/GO-102004-1895. <http://www.nrel.gov/docs/fy04osti/31254.pdf>

Small Wind Electric Systems: A Guide Produced for the Tennessee Valley Authority. (2004). 27 pp.; NREL Report No. BR-500-35818; DOE/GO-102004-1897. <http://www.nrel.gov/docs/fy04osti/35818.pdf>

Small Wind Electric Systems: An Idaho Consumer's Guide (Revised). (2004). 27 pp.; NREL Report No. BR-500-36432; DOE/GO-102004-1961. <http://www.nrel.gov/docs/fy04osti/36432.pdf>

Small Wind Electric Systems: A Kansas Consumer's Guide (Revision). (2004). 27 pp.; NREL Report No. BR-500-36249; DOE/GO-102004-1939. <http://www.nrel.gov/docs/fy04osti/36249.pdf>

Small Wind Electric Systems: A Maryland Consumer's Guide. (2004). 27 pp.; NREL Report No. BR-500-36411; DOE/GO-102004-1956. <http://www.nrel.gov/docs/fy04osti/36411.pdf>

Small Wind Electric Systems: A Montana Consumer's Guide (Revised). (2004). 27 pp.; NREL Report No. BR-500-36410; DOE/GO-102004-1955. <http://www.nrel.gov/docs/fy04osti/36410.pdf>

Small Wind Electric Systems: A New Mexico Consumer's Guide (Revised). (2004). 27 pp.; NREL Report No. BR-500-36710; DOE/GO-102004-1987. <http://www.nrel.gov/docs/fy04osti/36710.pdf>

Small Wind Electric Systems: A North Carolina Consumer's Guide. (2004). 27 pp.; NREL Report No. BR-500-35203; DOE/GO-102004-1896. <http://www.nrel.gov/docs/fy04osti/35203.pdf>

Small Wind Electric Systems: A Pennsylvania Consumer's Guide (Revised). (2004). 27 pp.; NREL Report No. BR-500-36711; DOE/GO-102004-1988. <http://www.nrel.gov/docs/fy04osti/36711.pdf>

Small Wind Electric Systems: A U.S. Consumer's Guide (Revised). (2004). 27 pp.; NREL Report No. BR-500-36680; DOE/GO-102004-1984. <http://www.nrel.gov/docs/fy04osti/36680.pdf>

Small Wind Electric Systems: A Wisconsin Consumer's Guide. (2004). 27 pp.; NREL Report No. BR-500-35120; DOE/GO-102004-1807. <http://www.nrel.gov/docs/fy04osti/35120.pdf> ♦



A Strong Energy Portfolio for a Strong America

Energy efficiency and clean, renewable energy will mean a stronger economy, a cleaner environment, and greater energy independence for America. Working with a wide array of state, community, industry, and university partners, the U.S. Department of Energy's Office of Energy Efficiency and Renewable Energy invests in a diverse portfolio of energy technologies.

Key Contacts

U.S. Department of Energy

Peter Goldman, Director
Office of Wind and Hydropower Technologies
Energy Efficiency and Renewable Energy
1000 Independence Avenue, SW, Washington, DC 20585

National Renewable Energy Laboratory

Robert Thresher, Director
National Wind Technology Center
1617 Cole Boulevard, Golden, CO 80401

Brian Smith, Technology Manager
Wind and Hydropower Technologies
National Wind Technology Center
1617 Cole Boulevard, Golden, CO 80401

Sandia National Laboratories

Paul Veers, Ph.D., Manager
Wind Energy Technology Department
P.O. Box 5800, Albuquerque, NM 87185-0708

NOTICE: This report was prepared as an account of work sponsored by an agency of the United States government. Neither the United States government nor any agency thereof, nor any of their employees, makes any warranty, express or implied, or assumes any legal liability or responsibility for the accuracy, completeness, or usefulness of any information, apparatus, product, or process disclosed, or represents that its use would not infringe privately owned rights. Reference herein to any specific commercial product, process, or service by trade name, trademark, manufacturer, or otherwise does not necessarily constitute or imply its endorsement, recommendation, or favoring by the United States government or any agency thereof. The views and opinions of authors expressed herein do not necessarily state or reflect those of the United States government or any agency thereof.

Available electronically at www.doe.gov/bridge

Available for a processing fee to U.S. Department of Energy and its contractors, in paper, from:

U.S. Department of Energy
Office of Scientific and Technical Information
P.O. Box 62
Oak Ridge, TN 37831-0062
phone: 865.576.8401
fax: 865.576.5728
email: reports@adonis.osti.gov

Available for sale to the public, in paper, from:

U.S. Department of Commerce
National Technical Information Service
5285 Port Royal Road
Springfield, VA 22161
phone: 800.553.6847
fax: 703.605.6900
email: orders@ntis.fedworld.gov
online ordering: www.ntis.gov/ordering.htm

PHOTO CREDITS: Page 2: American Electric Power/PIX 13884. Page 4: GE Energy/PIX 13887. Page 6: NREL/PIX 13886. Page 7: NREL/PIX 13888. Page 8: NREL/PIX 13956. Sandia National Laboratories/PIX 13957. Page 9: NREL/PIX 13885. NREL/PIX 13889. Page 10: SNL/PIX 13890. Page 11: NREL/PIX 13175. Page 13: Bat Conservation International/PIX 13891. Page 14: Craig Cox/PIX 11929. Page 17: Tjaden Farms/PIX 13764. NREL/PIX 12586. Sandia National Laboratories/PIX 04678

For more information contact:

EERE Information Center
1-877-EERE-Inf (1-877-337-3463)
www.eere.energy.gov

Produced for the



U.S. Department of Energy
**Energy Efficiency
and Renewable Energy**

Bringing you a prosperous future where energy
is clean, abundant, reliable, and affordable

1000 Independence Avenue, SW, Washington, DC 20585

By the National Renewable Energy Laboratory,
a DOE National laboratory

DOE/GO-102005-2115

April 2005

Printed with renewable-source ink on paper containing at least 50% wastepaper, including 20% postconsumer waste